

JVC



ENGLISH

DEUTSCH

FRANÇAIS

NEDERLANDS

CD RECEIVER CD-RECEIVER RECEPTEUR CD CD-RECEIVER

KD-LX330R

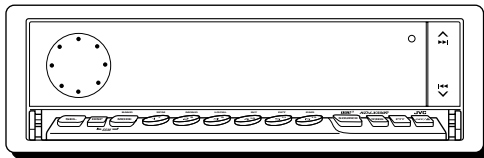
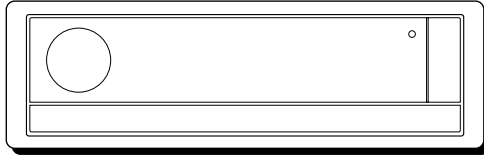

For installation and connections, refer to the separate manual.

Angaben zu Einbau und Verkabelung entnehmen Sie bitte der gesonderten Anleitung.

Pour l'installation et les raccordements, se référer au manuel séparé.

Zie de afzonderlijke handleiding voor details aangaande het installeren en verbinden van het toestel.

INSTRUCTIONS

BEDIENUNGSANLEITUNG
MANUEL D'INSTRUCTIONS
GEBRUIKSAANWIJZING

For Customer Use:

Enter below the password you have entered for your security lock.

Retain this password for future reference.

PASSWORD:

Position And Reproduction Of Labels

Bottom panel of the main unit

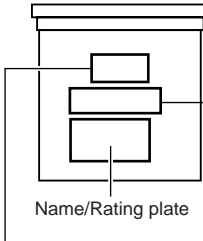

CAUTION: Invisible laser radiation when open and interlock failed or defeated. AVOID DIRECT EXPOSURE TO BEAM.	ADVARSEL: Usynlig laserstråling ved åbning, når sikkerhedsafbrydere er ude af funktion. Undgå direkte belysning for stråling.	VARNING: Osynlig laserstråling når denna del är öppnad och spärren är urkopplad. Beträkta strålen.	VARO: Avattaessa ja suojalukitus ohitettaessa olet alttiina näkömattomalle lasersäteilylle. Älä katso säteeseen.
(e)	(e)	(d)	(s) (f)



Caution:
This product contains a laser component of higher laser class than Class 1.

IMPORTANT FOR LASER PRODUCTS

Precautions:

- CLASS 1 LASER PRODUCT**
- CAUTION:** Invisible laser radiation when open and interlock failed or defeated. Avoid direct exposure to beam.
- CAUTION:** Do not open the top cover. There are no user-serviceable parts inside. Leave all servicing to qualified service personnel.
- CAUTION:** This CD player uses invisible laser radiation and is equipped with safety switches to prevent radiation emission when unloading CDs. It is dangerous to defeat the safety switches.
- CAUTION:** Use of controls, adjustments or performance of procedures other than those specified herein may result in hazardous radiation exposure.

How to reset your unit

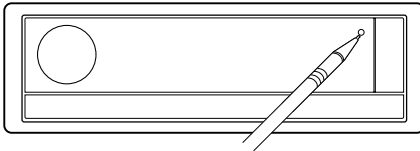

Press the reset button on the front panel using a ball-point pen or a similar tool. This will reset the built-in microcomputer.

Note:
Your preset adjustments — such as preset channels or sound adjustments — will also be erased.

Note:
For security reasons, a numbered ID card is provided with this unit, and the same ID number is imprinted on the unit's chassis. Keep the card in a safe place, as it will help the authorities to identify your unit if stolen.

CAUTION on Volume Setting

CDs produce very little noise compared with other sources. If the volume level is adjusted for the tuner, for example, the speakers may be damaged by the sudden increase in the output level. Therefore, lower the volume before playing a disc and adjust it as required during playback.

Thank you for purchasing a JVC product. Please read all instructions carefully before operation, to ensure your complete understanding and to obtain the best possible performance from the unit.

CONTENTS

LOCATION OF THE BUTTONS	4	OTHER MAIN FUNCTIONS	22
Control panel	4	Setting the clock	22
Remote controller	5	Changing the general settings (PSM)	22
Preparing the remote controller	6	Controlling the volume automatically (Audio Cruise)	26
BASIC OPERATIONS	7	Assigning names to the sources	28
RADIO BASIC OPERATIONS	8	Using the security lock	30
Listening to the radio	8	CD CHANGER OPERATIONS	32
Storing stations in memory	9	Playing CDs	32
Tuning into a preset station	10	Selecting CD playback modes	33
RDS OPERATIONS	11	EXTERNAL COMPONENT OPERATIONS ...	35
What you can do with RDS EON	11	Playing an external component	35
Other convenient RDS functions and adjustments	14	Using a subwoofer	35
CD OPERATIONS	16	DAB TUNER OPERATIONS	36
Playing a CD	16	Tuning into an ensemble and one of the services	36
Locating a track or a particular portion on a CD	17	Storing DAB services in memory	37
Selecting CD playback modes	17	Tuning into a preset DAB service	38
Prohibiting CD ejection	18	What you can do more with DAB	39
Playing a CD Text	18	ADDITIONAL INFORMATION	40
SOUND ADJUSTMENTS	19	TROUBLESHOOTING	41
Adjusting the sound	19	MAINTENANCE	42
Using the sound control memory	20	Handling CDs	42
Storing your own sound adjustments	21	SPECIFICATIONS	43

About the demonstration mode (DEMO MODE)...

When shipped from the factory, "DEMO MODE" is set to "DEMO ON" in this unit. The demonstration will start automatically if no sound comes in for 3 minutes. (See page 26.)

To activate the display demonstration manually

While holding DISP, press **▲ ►►** until "DEMO" appears on the display.

Various functions and display illumination modes equipped with this unit will be demonstrated repeatedly in sequence. During the display demonstration, "DEMO" flashes on the display.

To turn off the display demonstration, press **▲ ►►** again for a few seconds while holding DISP.

- The display demonstration will turn off automatically after about 1 hour.

BEFORE USE

*For safety....

- Do not raise the volume level too much, as this will block outside sounds, making driving dangerous.
- Stop the car before performing any complicated operations.

*Temperature inside the car....

If you have parked the car for a long time in hot or cold weather, wait until the temperature in the car becomes normal before operating the unit.



LOCATION OF THE BUTTONS

ENGLISH

Control panel

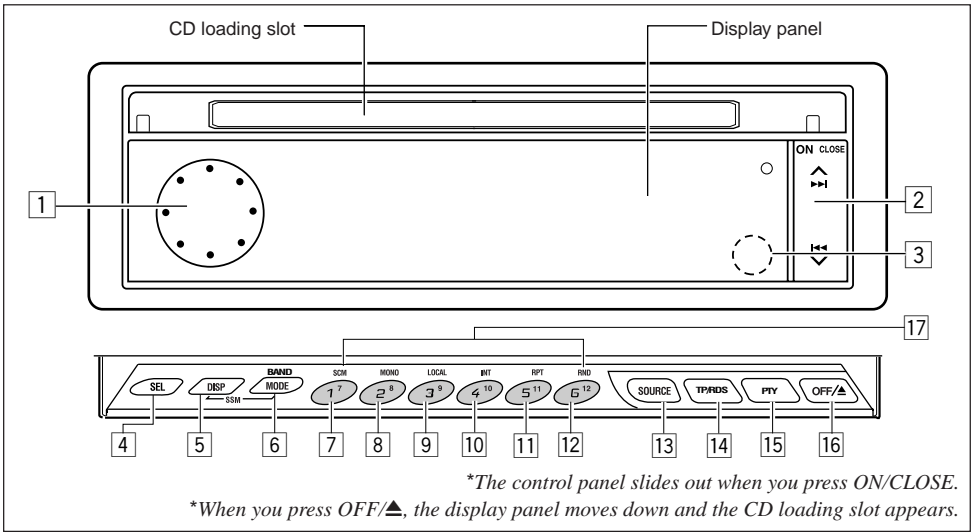

- | | |
|---|--|
| <p>1 Control dial</p> <p>2 ▲▶▶▶/ ◀◀◀▼ button</p> <ul style="list-style-type: none"> • ▲▶▶▶/ ◀◀◀▼ also functions as ON or CLOSE button. <p>3 Remote sensor</p> <p>4 SEL (select) button</p> <p>5 DISP (display) button</p> <ul style="list-style-type: none"> • Also functions as SSM buttons when pressed together with the MODE BAND button. <p>6 MODE BAND button</p> <ul style="list-style-type: none"> • Also functions as SSM buttons when pressed together with the DISP button. | <p>7 SCM (sound control memory) button</p> <p>8 MONO button</p> <p>9 LOCAL button</p> <p>10 INT (intro) button</p> <p>11 RPT (repeat) button</p> <p>12 RND (random) button</p> <p>13 SOURCE button</p> <p>14 TP (traffic programme)/RDS (radio data system) button</p> <p>15 PTY (programme type) button</p> <p>16 OFF/▲ (eject) button</p> <p>17 Number buttons</p> |
|---|--|

How to use the number buttons:

After pressing MODE BAND, the number buttons work as different function buttons (while "MODE" remains on the display).

To use these buttons as number buttons after pressing MODE BAND, wait for 5 seconds without pressing any number button so that "MODE" disappears from the display.

- Pressing MODE BAND again also erases "MODE" from the display.

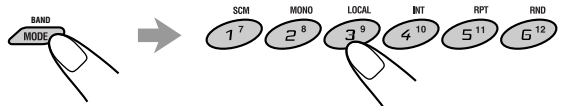



Remote controller

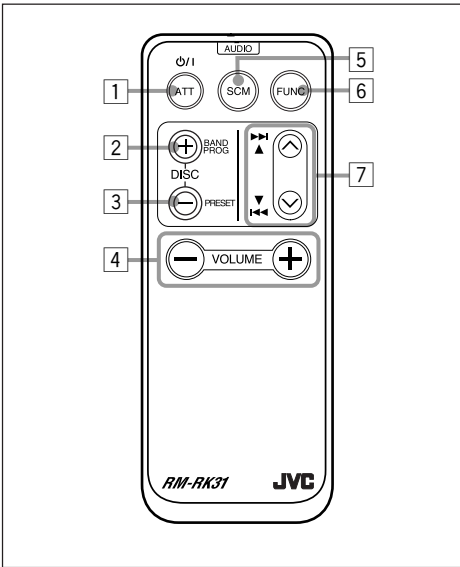

- 1 • Turns on the unit if pressed when the unit is turned off.
 - Turns off the unit if pressed and held until "SEE YOU" appears on the display.
 - Drops the volume level for a moment if pressed briefly.
Press again to resume the volume.
- 2 • Functions as the BAND button while listening to the radio (or the DAB tuner).
Each time you press the button, the band changes.
 - Functions as the DISC + button while listening to the CD changer.
Each time you press the button, the disc number increases, and the selected disc starts playing.
 - Does not function as the PROG button.

- 3 • Functions as the PRESET button while listening to the radio (or the DAB tuner).
Each time you press the button, the preset station number increases, and the selected station is tuned in.
 - Functions as the DISC – button while listening to the CD changer.
Each time you press the button, the disc number decreases, and the selected disc starts playing.
- 4 Functions the same as the control dial on the main unit.

NOTE: This button does not function for the preferred setting mode adjustment.

- 5 Selects the sound mode.
Each time you press SCM (Sound Control Memory), the mode changes.
- 6 Selects the source.
Each time you press FUNC (function), the source changes.
- 7 • Searches stations while listening to the radio.
 - Selects services while listening to the DAB tuner if pressed briefly.
 - Searches ensembles while listening to the DAB tuner if pressed for more than 1 second.
 - Fast-forwards or reverses the track if pressed and held while listening to a CD.
 - Skips to the beginning of the next track or goes back to the beginning of the current (or previous) track if pressed briefly while listening to a CD.



Preparing the remote controller

Before using the remote controller:

- Aim the remote controller directly at the remote sensor on the main unit. Make sure there is no obstacle in between.

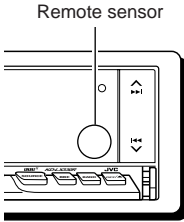

- Do not expose the remote sensor to strong light (direct sunlight or artificial lighting).

Installing the battery

When the controllable range or effectiveness of the remote controller decreases, replace the battery.

1. Remove the battery holder.

- 1) Push out the battery holder in the direction indicated by the arrow using a ball-point pen or a similar tool.
- 2) Remove the battery holder.

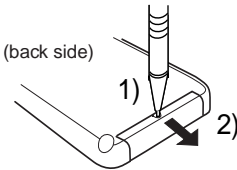

2. Place the battery.

Slide the battery into the holder with the + side facing upwards so that the battery is fixed in the holder.

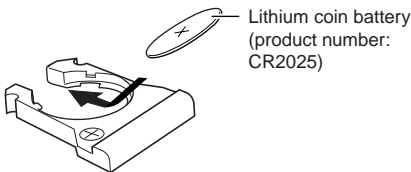

3. Return the battery holder.

Insert again the battery holder pushing it until you hear a clicking sound.

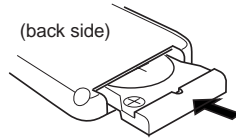

WARNING:

- Store the batteries in a place which children cannot reach.
If a child accidentally swallows the batteries, immediately consult a doctor.
- Do not recharge, short, disassemble or heat the batteries or dispose of in a fire.
Doing any of these things may cause the batteries to give off heat, crack or start a fire.
- Do not leave the batteries with other metallic materials.
Doing this may cause the batteries to give off heat, crack or start a fire.
- When throwing away or saving batteries, wrap in tape and insulate; otherwise, it may cause the batteries to give off heat, crack or start a fire.
- Do not poke the batteries with tweezers or similar tools.
Doing this may cause the batteries to give off heat, crack or start a fire.

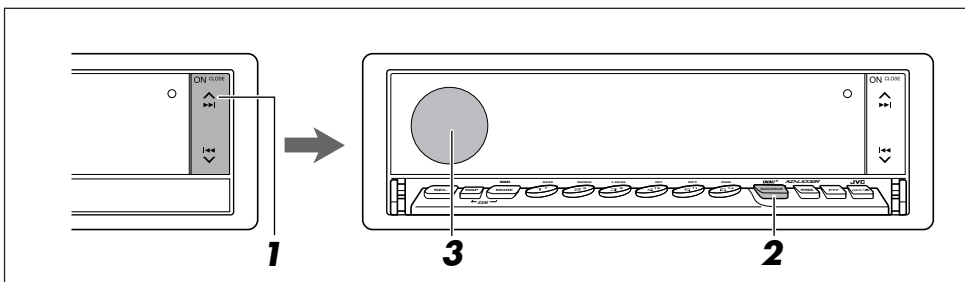

1 Turn on the power.

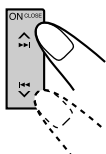

The display illuminates and the control panel and control dial come out.

2 Select the source.



Each time you press the button, the source changes as follows:

- FM → DAB tuner** → CD*
- CD changer** → External component
- AM → (back to the beginning)

* If a CD is not in the loading slot, you cannot select CD as the source to play.

** Without connecting the CD changer and/or the DAB tuner, you cannot select it as the source to play.

To operate the tuner (FM or AM),
see pages 8 – 15.

To operate the CD player,
see pages 16 – 18.

To operate the CD changer,
see pages 32 – 34.

To operate the external component,
see page 35.

To operate the DAB tuner,
see pages 36 – 39.

Note on display illustrations:

Illustrations will differ from what appears if "CLOCK DISP" is set to "CLK DISP OFF." See page 24.

3 Adjust the volume.

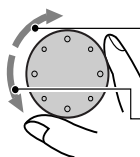

To increase the volume.

To decrease the volume.



Volume level meter

4 Adjust the sound as you want (see page 19).

To drop the volume in a moment

Press SOURCE for more than 1 second while listening to any source. "ATT" starts flashing on the display, and the volume level will drop in a moment. To resume the previous volume level, press the button for more than 1 second again.

To turn off the power

Press and hold OFF/▲ until "SEE YOU" appears on the display.

Note:

When you use this unit for the first time, set the built-in clock correctly, see page 22.

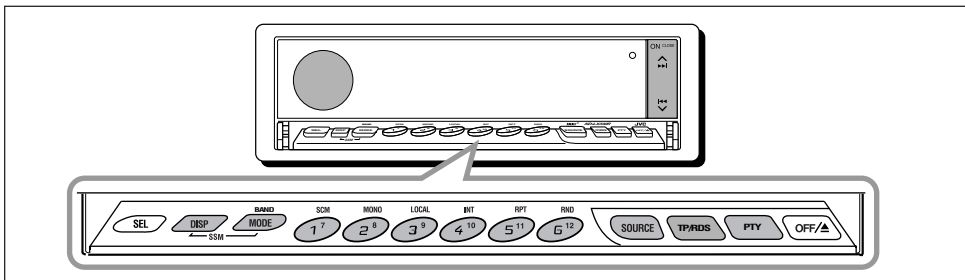

Listening to the radio

You can use either automatic searching or manual searching to tune into a particular station.

Searching a station automatically: Auto search

1 Select the band.

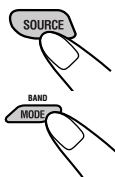

- 1 Press SOURCE to select FM or AM as the source.
- 2 If necessary, press and hold MODE BAND to select the FM band number (FM1, FM2 or FM3).

Each time you press and hold the button, the FM band changes as follows:

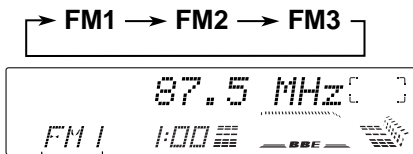

Selected band appears.

Note:

This receiver has three FM bands (FM1, FM2, FM3). You can use any one of them to listen to an FM broadcast.

2 Start searching a station.

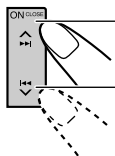

- Press to search stations of higher frequencies.
- Press to search stations of lower frequencies.

When a station is received, searching stops.

To stop searching before a station is received, press the same button you have pressed for searching.

To tune in FM stations only with strong signals

- 1 Press MODE BAND.
“MODE” appears on the lower part of the display, and the number buttons can work as different function buttons.
- 2 Press LOCAL, while “MODE” is still on the display, so that the LOCAL indicator lights up on the display.
This function works only while searching FM stations, including SSM preset (see page 9). Each time you press the button, the LOCAL indicator lights up and goes off alternately.

Searching a station manually: Manual search

1 Select the band.

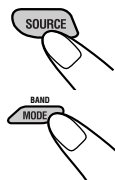

- 1 Press SOURCE to select FM or AM as the source.
- 2 If necessary, press and hold MODE BAND to select the FM band number (FM1, FM2 or FM3).

Each time you press and hold the button, the FM band changes as follows:



Note:

This receiver has three FM bands (FM1, FM2, FM3). You can use any one of them to listen to an FM broadcast.

- 2** Press and hold **▲▶▶** or **◀◀▼** until **"M"** (manual) starts flashing on the display.

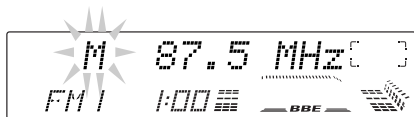

- 3** Tune into a station you want while **"M"** is flashing.

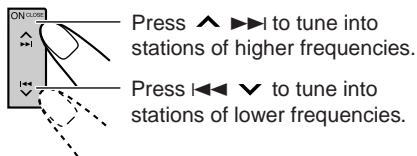

- If you release your finger from the button, the manual mode will automatically turn off after 5 seconds.
- If you hold down the button, the frequency keeps changing (in 50 kHz intervals for FM and 9 kHz intervals for AM — MW/LW) until you release the button.

Storing stations in memory

You can use one of the following two methods to store broadcasting stations in memory.

- Automatic preset of FM stations: SSM (Strong-station Sequential Memory)
- Manual preset of both FM and AM stations

FM station automatic preset: SSM

You can preset 6 local FM stations in each FM band (FM1, FM2 and FM3).

- 1** Select the FM band (FM1–3) you want to store FM stations into.

- 1 Press **SOURCE** to select FM as the source.
- 2 If necessary, press and hold **MODE BAND** to select the FM band number (FM1, FM2 or FM3).

Each time you press and hold the button, the FM band changes as follows:



- 2** Press and hold both buttons for more than 2 seconds.

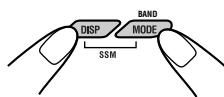

"SSM" appears, then disappears when automatic preset is over.

When an FM stereo broadcast is hard to receive:

- 1 Press **MODE BAND** while listening to an FM stereo broadcast (the **ST** indicator lights up while receiving an FM stereo broadcast). "MODE" appears on the lower part of the display, and the number buttons can work as different function buttons.
- 2 Press **MONO**, while "MODE" is still on the display, so that the **MO** indicator lights up on the display. The sound you hear becomes monaural but the reception will be improved (the **ST** indicator goes off).

Each time you press the button, the **MO** indicator lights up and goes off alternately.

Local FM stations with the strongest signals are searched and stored automatically in the band number you have selected (FM1, FM2 or FM3). These stations are preset in the number buttons — No.1 (lowest frequency) to No.6 (highest frequency).

When automatic preset is over, the station stored in number button 1 will be automatically tuned in.



Manual preset

You can preset up to 6 stations in each band (FM1, FM2, FM3 and AM) manually.

Ex.: Storing an FM station of 88.3 MHz into the preset number 1 of the FM1 band

1 Select the band (FM1).

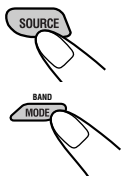

- 1 Press SOURCE to select FM as the source.
- 2 Press and hold MODE BAND repeatedly to select the FM1 band.

2 Tune into a station of 88.3 MHz.

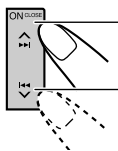

Press \blacktriangle \blacktriangleright to tune into stations of higher frequencies.

Press \blacktriangleleft \blacktriangleright to tune into stations of lower frequencies.

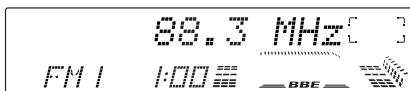

3 Press and hold the number button (in this example, 1) for more than 2 seconds.

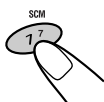

Band number and "MEMO" appear alternately for a while.

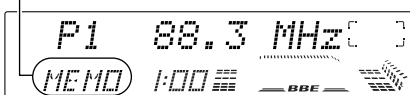

4 Repeat the above procedure to store other stations into other preset numbers.

Notes:

- A previously preset station is erased when a new station is stored in the same preset number.
- Preset stations are erased when the power supply to the memory circuit is interrupted (for example, during battery replacement). If this occurs, preset the stations again.

Tuning into a preset station

You can easily tune into a preset station. Remember that you must store stations first. If you have not stored them yet, see "Storing stations in memory" on pages 9 and 10.

1 Select the band.

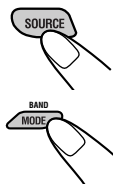

- 1 Press SOURCE to select FM or AM as the source.
- 2 If necessary, press and hold MODE BAND to select the FM band number (FM1, FM2 or FM3).

Each time you press and hold the button, the FM band changes as follows:



2 Select the number (1 – 6) for the preset station you want.

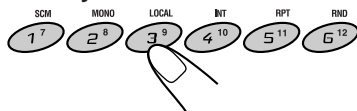

If the sound quality decreases and the stereo effect is lost while listening to an FM station

In some areas, adjacent stations may interfere with each other. If this interference occurs, this unit can automatically reduce this interference noise (the initial setting when shipped from the factory). However, in this case, the sound quality will be degraded and the stereo effect will be also lost.

If you do not want to degrade the sound quality and to lose the stereo effect, rather than to eliminate the interference noise, see "To change the FM tuner selectivity — IF FILTER" on page 26.



What you can do with RDS EON

RDS (Radio Data System) allows FM stations to send an additional signal along with their regular programme signals. For example, the stations send their station names, as well as information about what type of programme they broadcast, such as sports or music, etc.

Another advantage of RDS function is called “EON (Enhanced Other Networks).” The EON indicator lights up while receiving an FM station with the EON data. By using the EON data sent from a station, you can tune into a different station of a different network broadcasting your favourite programme or traffic announcement while listening to another programme or to another source such as CD.

By receiving the RDS data, this unit can do the following:

- Tracing the same programme automatically (Network-Tracking Reception)
- Standby Reception of TA (Traffic Announcement) or your favourite programme
- PTY (Programme Type) search
- Programme search
- And some other functions

Tracing the same programme automatically (Network-Tracking Reception)

When driving in an area where FM reception is not good, the tuner built in this unit automatically tunes into another RDS station, broadcasting the same programme with stronger signals. So, you can continue to listen to the same programme in its finest reception, no matter where you drive. (See the illustration on the next page.)

Two types of the RDS data are used to make Network-Tracking Reception work correctly — PI (Programme Identification) and AF (Alternative Frequency).

Without receiving these data correctly from the RDS station you are listening to, Network-Tracking Reception will not operate.

To use **Network-Tracking Reception**, press and hold TP/RDS (traffic programme/radio data system) for more than 1 second. Each time you press and hold the button, Network-Tracking Reception modes change as follows:

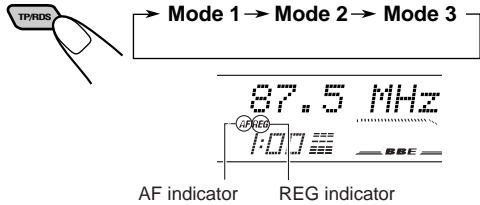

Mode 1

The AF indicator lights up but the REG indicator does not.

Network-Tracking Reception is activated with Regionalization set to “off.”

Switches to another station within the same network when the receiving signals from the current station become weak.

- *In this mode, the programme may differ from the one currently received.*

Mode 2

Both the AF indicator and the REG indicator light up.

Network-Tracking Reception is activated with Regionalization set to “on.”

Switches to another station, within the same network, broadcasting the same programme when the receiving signals from the current station become weak.

Mode 3

Neither the AF indicator nor the REG indicator lights up.

Network-Tracking Reception is deactivated.

Note:

If a DAB tuner is connected and Alternative Reception (for DAB services) is activated, Network-Tracking Reception is also activated automatically. On the other hand, Network-Tracking Reception cannot be deactivated without deactivating Alternative Reception. (See page 39.)



The same programme can be received on different frequencies.

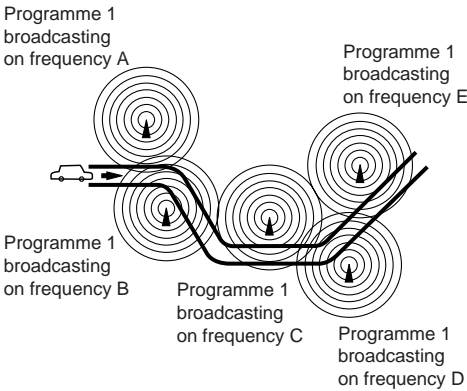

Using Standby Reception

Standby Reception allows the unit to switch temporarily to your favourite programme (PTY: Programme Type) and Traffic Announcement (TA) from the current source (another FM station, CD and other connected components).

- Standby Reception will not work if you are listening to an AM station.

TA Standby Reception



When you press TP/RDS while listening to an FM station, the TP indicator is lit during reception of a TP (Traffic Programme) station and the TA standby mode is engaged.

- When the station being received is not a TP station, the TP indicator flashes. Press **▲▶▶** or **◀◀▼** to engage the TA standby mode. "SEARCH" appears on the display, and TP station search starts. When a TP station is tuned in, the TP indicator is lit.
- If you are listening to a CD or other connected components and wish to listen to a TP station, press TP/RDS to enter the TA standby mode. (The TP indicator lights up.)

If a traffic programme starts broadcasting while the TA standby mode is active, "TRAFFIC" appears and the playback source changes to the FM band. The volume increases to the preset TA volume level (see page 15) and the traffic programme can be heard.

To deactivate the TA standby mode, press TP/RDS again.

PTY Standby Reception

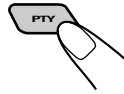

When you press PTY while listening to an FM station, the PTY indicator is lit during reception of a PTY station and the PTY standby mode is engaged. The selected PTY name stored on page 13 flashes for 5 seconds.

- When the station being received is not a PTY station, the PTY indicator flashes. Press **▲▶▶** or **◀◀▼** to engage the PTY standby mode. "SEARCH" appears on the display, and PTY station search starts. When a PTY station is tuned in, the PTY indicator is lit.
 - If you are listening to a CD or other connected components and wish to listen to a selected PTY broadcast, press PTY to enter the PTY standby mode. (The PTY indicator lights up.)
- If the selected PTY programme starts broadcasting while the PTY standby mode is active, the selected PTY name appears and the playback source changes to the FM band. The selected PTY programme can then be heard.
- To deactivate the PTY standby mode, press PTY again.



Selecting your favourite programme for PTY Standby Reception

You can select your favourite programme for PTY Standby Reception to store in memory. When shipped from the factory, "NEWS" is stored as the programme type for PTY Standby Reception.

- 1 Press and hold SEL (select) for more than 2 seconds so that one of the PSM items appears on the display. (PSM: see page 23.)**

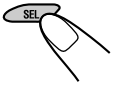

- 2 Select "PTY STANDBY" if not shown on the display.**

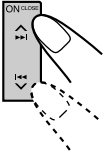

- 3 Select one of twenty-nine PTY codes.**

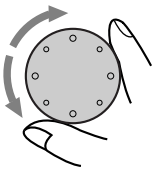

Selected code name appears on the display and is stored into memory.

As you turn the control dial, the PTY codes change as follows:

PTY codes

NEWS ⇄ AFFAIRS ⇄ INFO ⇄
 SPORT ⇄ EDUCATE ⇄ DRAMA ⇄
 CULTURE ⇄ SCIENCE ⇄ VARIED ⇄
 POP M ⇄ ROCK M ⇄ EASY M ⇄
 LIGHT M ⇄ CLASSICS ⇄ OTHER M ⇄
 WEATHER ⇄ FINANCE ⇄ CHILDREN ⇄
 SOCIAL ⇄ RELIGION ⇄ PHONE IN ⇄
 TRAVEL ⇄ LEISURE ⇄ JAZZ ⇄
 COUNTRY ⇄ NATION M ⇄ OLDIES ⇄
 FOLK M ⇄ DOCUMENT ⇄ (back to the beginning)

For details, see page 40.

- 4 Press SEL (select) to finish the setting.**



Searching your favourite programme

You can search one of your 6 favourite programme types stored in memory.

When shipped from the factory, the following 6 programme types have been stored in the number buttons (1 to 6).

To store your favourite programme types, see below.

To search your favourite programme type, see page 14.

1	2	3
POP M	ROCK M	EASY M
4	5	6
CLASSICS	AFFAIRS	VARIED

To store your favourite programme types

- 1 Press and hold SEL (select) for more than 2 seconds so that one of the PSM items appears on the display. (PSM: see page 23.)**

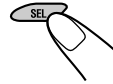

- 2 Select "PTY SEARCH" if not shown on the display.**

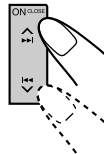

- 3 Select one of twenty-nine PTY codes. (See left column.)**

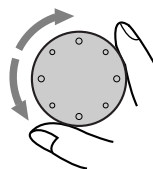

Selected code name appears on the display.

- If the code already stored in memory is selected, it will flash on the display.



4 Press and hold the number button for more than 2 seconds to store the PTY code selected into the preset number you want.

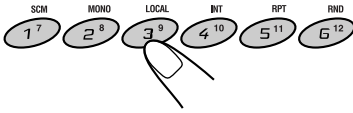

PTY preset number appears, and selected code name and "MEMORY" alternate on the display.

5 Press SEL (select) to finish the setting.



To search your favourite programme type

1 Press and hold PTY (programme type) for more than 1 second while listening to an FM station.

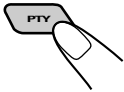

The last selected PTY code and preset number appear.



2 Select one of the PTY codes stored in preset number buttons (1 to 6).

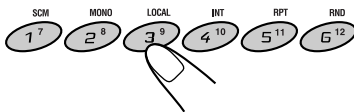

PTY search for your favourite programme starts after 5 seconds.

- If there is a station broadcasting a programme of the same PTY code you selected, that station is tuned in.
- If there is no station broadcasting a programme of the same PTY code you selected, the station will not change.

Note:

In some areas, the PTY search will not work correctly.

Other convenient RDS functions and adjustments

Automatic selection of the station when using the number buttons

Usually when you press the number button, the preset station is tuned in.

However, when the preset station is an RDS station, something different will happen. If the signals from that preset station are not sufficient for good reception, this unit, using the AF data, tunes in another frequency broadcasting the same programme as the original preset station is broadcasting.

In case no other station is tuned in, you can also search all receivable frequencies for the same programme (Programme search).

To activate programme search, follow the procedure below.

- Programme search takes a while.
- See also "Changing the general settings (PSM)" on page 22.

1 Press and hold SEL (select) for more than 2 seconds so that one of the PSM items appears on the display.

2 Press **▲▶▶** or **◀◀▼** to select "P(Programme)-SEARCH."

3 Turn the control dial to select "SEARCH ON." Now programme search is activated.

4 Press SEL (select) to finish the setting.

To cancel programme search, repeat the same procedure and select "SEARCH OFF" in step 3 by turning the control dial counterclockwise.



Changing the display mode while listening to an FM station

You can change the initial indication on the display to either station name (PS NAME) or to station frequency (FREQUENCY), while listening to an FM RDS station.

- See also “Changing the general settings (PSM)” on page 22.

- 1 Press and hold SEL (select) for more than 2 seconds so that one of the PSM items appears on the display.
- 2 Press \wedge \blacktriangleright or \blacktriangleleft \vee to select “TUNER DISP” (tuner display).
- 3 Turn the control dial to set to the desired indication (“PS NAME” or “FREQUENCY”).
- 4 Press SEL (select) to finish the setting.

Note:

By pressing DISP, you can also change the display while listening to an FM RDS station.

Each time you press the button, the following information appears on the display:

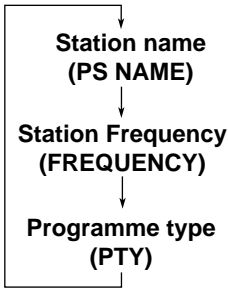

- Then, the display goes back to the original indication in several seconds.

Setting the TA volume level

You can preset the volume level for TA Standby Reception. When a traffic programme is received, the volume level automatically changes to the preset level.

- See also “Changing the general settings (PSM)” on page 22.

- 1 Press and hold SEL (select) for more than 2 seconds so that one of the PSM items appears on the display.
- 2 Press \wedge \blacktriangleright or \blacktriangleleft \vee to select “TA VOLUME.”
- 3 Turn the control dial to set to the desired volume. You can set it from “VOL 00” to “VOL 50.”
- 4 Press SEL (select) to finish the setting.

Automatic clock adjustment

When shipped from the factory, the clock built in this unit is set to be readjusted automatically using the CT (Clock Time) data in the RDS signal.

If you do not want to use automatic clock adjustment, follow the procedure below.

- See also “Changing the general settings (PSM)” on page 22.

- 1 Press and hold SEL (select) for more than 2 seconds so that one of the PSM items appears on the display.
- 2 Press \wedge \blacktriangleright or \blacktriangleleft \vee to select “AUTO ADJUST.”
- 3 Turn the control dial to select “ADJUST OFF.” Now automatic clock adjustment is canceled.
- 4 Press SEL (select) to finish the setting.

To reactivate clock adjustment, repeat the same procedure and select “ADJUST ON” in step 3.

Note:

You must stay tuned to the same station for more than 2 minutes after setting “AUTO ADJUST” to “ADJUST ON.” Otherwise, the clock time will not be adjusted. (This is because the unit takes up to 2 minutes to capture the CT data in the RDS signal.)



CD OPERATIONS

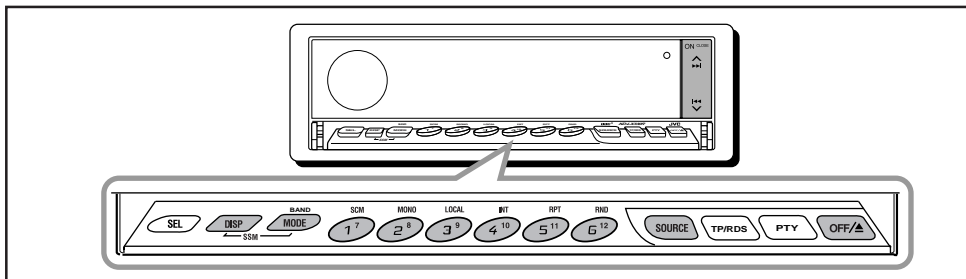

Playing a CD

1 Open the loading slot.

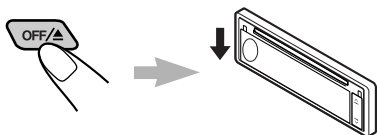

The display panel moves down, and the loading slot appears.

2 Insert a disc into the loading slot.

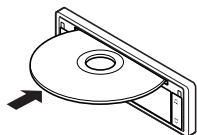

The unit draws in a CD, the display panel moves up, and CD play starts automatically.



The CD indicator lights up.

Total track number of the inserted disc Total playing time of the inserted disc



Current track Elapsed playing time

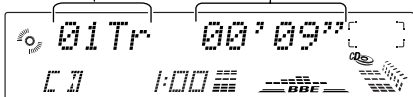

Notes:

- When a CD is in the loading slot, selecting “CD” as the source by pressing SOURCE starts CD play.
- When a CD is inserted upside down, the CD automatically ejects. (“DISC EJECT” appears on the display.)
- When you play a CD Text, the disc title and performer appear on the display. Then the current track title appears on the display, followed by the track number and elapsed playing time. See also “Playing a CD Text” (page 18) and “To select the scroll mode — SCROLL MODE” (page 25). If a CD Text includes much text information, some may not appear on the display.
- If you change the source, CD play also stops (without ejecting the CD).

To stop play and eject the CD

Press OFF/▲ briefly.

CD play stops, the display panel moves down, then the CD automatically ejects from the loading slot.

To move up the display panel, press ▲▶▶ or ◀◀▼. If no button is pressed, the display panel will move up in about 5 minutes.

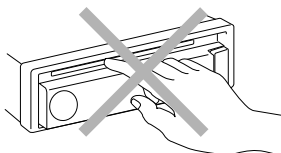

CAUTION: NEVER insert your finger between the display panel and the unit, as it may get caught in the unit.

Note:

If the ejected disc is not removed for about 15 seconds, the disc is automatically inserted again into the loading slot to protect it from dust. (CD play will not start this time.)



Locating a track or a particular portion on a CD

To fast-forward or reverse the track

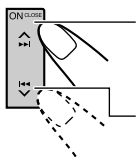

Press and hold **▲▶▶▶**, while playing a CD, to fast-forward the track.

Press and hold **◀◀◀▼**, while playing a CD, to reverse the track.

To go to the next tracks or the previous tracks

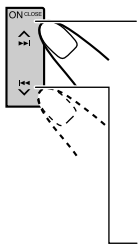

Press **▲▶▶▶** briefly, while playing a CD, to go ahead to the beginning of the next track. Each time you press the button consecutively, the beginning of the next tracks is located and played back.

Press **◀◀◀▼** briefly, while playing a CD, to go back to the beginning of the current track. Each time you press the button consecutively, the beginning of the previous tracks is located and played back.

To go to a particular track directly

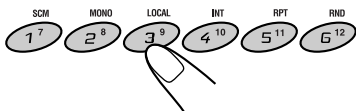

Press the number button corresponding to the track number to start its playback.

- To select a track number from 1 – 6:
Press 1 (7) – 6 (12) briefly.
- To select a track number from 7 – 12:
Press and hold 1 (7) – 6 (12) for more than 1 second.

Selecting CD playback modes

To play back tracks at random (Random Play)

You can play back all tracks on the CD at random.

- Press MODE BAND while playing a CD. “MODE” appears on the lower part of the display, and the number buttons can work as different function buttons.
 - Press RND (random), while “MODE” is still on the display, so that the RND indicator lights up on the display.
- Each time you press the button, CD random play mode turns on and off alternately.



The RND indicator

When the random mode is turned on, the RND indicator lights up on the display and a track randomly selected starts playing.

To play back tracks repeatedly (Repeat Play)

You can play back the current track repeatedly.

- Press MODE BAND while playing a CD. “MODE” appears on the lower part of the display, and the number buttons can work as different function buttons.
 - Press RPT (repeat), while “MODE” is still on the display, so that the RPT indicator lights up on the display.
- Each time you press the button, CD repeat play mode turns on and off alternately.

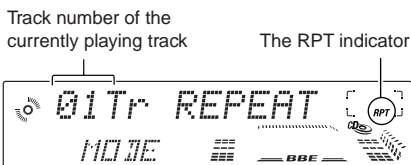

Track number of the currently playing track

The RPT indicator

When the repeat mode is turned on, the RPT indicator lights up on the display.



To play back only intros (Intro Scan)

You can play back the first 15 seconds of each track sequentially.

1 Press MODE BAND while playing a CD.

"MODE" appears on the lower part of the display, and the number buttons can work as different function buttons.

2 Press INT (intro), while "MODE" is still on the display.

Each time you press the button, CD intro scan mode turns on and off alternately.

Track number of the currently playing track



When the intro scan mode is turned on, "INTRO" appears on the display for 5 seconds and the track number flashes.

Prohibiting CD ejection

You can prohibit CD ejection and can lock a CD in the loading slot.

While pressing SOURCE, press and hold OFF/▲ for more than 2 seconds. "NO EJECT" flashes on the display for about 5 seconds, and the CD is locked and cannot be ejected.



Note:

If you press OFF/▲ while CD ejection is prohibited, the control panel moves down, but the CD cannot be ejected. ("NO EJECT" appears on the display.)

To move up the display panel, press ▲ ►►► or ◀◀◀ ▼.

To cancel the prohibition and unlock the CD, press and hold OFF/▲ for more than 2 seconds again, while pressing SOURCE. "EJECT OK" flashes on the display for about 5 seconds, and the CD is unlocked.

Playing a CD Text

In a CD Text, some information about the disc (its disc title, performer and track title) is recorded. You can show these disc information on the display.

Select text display mode while playing a CD Text.

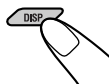

Each time you press the button, the display changes as follows:

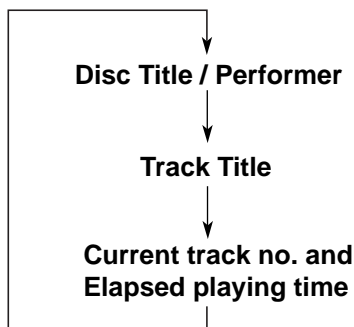

Notes:

- The display shows up to 12 characters at one time and scrolls if there are more than 12 characters. See also "To select the scroll mode — SCROLL MODE" on page 25.
- When you press DISP while playing a conventional CD, "NO NAME" appears for the disc title/performer and the track title.



Adjusting the sound

You can adjust the sound characteristics to your preference.

1 Select the item you want to adjust.



Each time you press the button, the adjustable items change as follows:

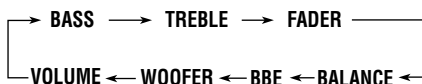

2 Adjust the level.

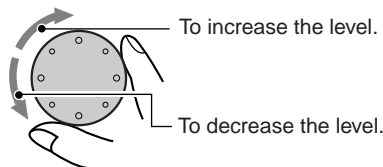

Equalization pattern changes as you adjust the bass or treble.

Note:

Normally the control dial works for volume adjustment. So you do not have to select “VOLUME” to adjust the volume level.

Indication	To do:	Range
BASS	Adjust the bass.	-06 (min.) +06 (max.)
TREBLE	Adjust the treble.	-06 (min.) +06 (max.)
FADER*	Adjust the front and rear speaker balance.	R06 (Rear only) F06 (Front only)
BALANCE	Adjust the left and right speaker balance.	L06 (Left only) R06 (Right only)
BBE	See “What is BBE?” on the next page.	OFF, 1, 2, 3
WOOFER	Adjust the subwoofer output level.	00 (min.) 08 (max.)
VOLUME	Adjust the volume.	00 (min.) 50 (max.)

* If you are using a two-speaker system, set the fader level to “00.”



What is BBE^{II}?

The BBE^{II}* function restores the brilliance and clarity of the original live sound in recording, broadcasts, etc.

When a speaker reproduces sound, it introduces frequency-dependent phase shifting, causing high-frequency sounds to take longer to reach the ear than low frequency sounds. The BBE^{II} function adjusts the phase relationship between the low, mid and high frequencies by adding a progressively longer delay time to the low and mid frequencies, so that all frequencies reach the listener's ears at the proper time.

In addition, the BBE^{II} function boosts low and high frequencies, which loudspeakers tend to be less efficient in reproducing, through dynamic, program-driven augmentation. When combined with the phase compensation feature, the resulting sound has a clearer, more finely detailed "live" presence.

As you turn the control dial, the BBE^{II} function changes as follows:

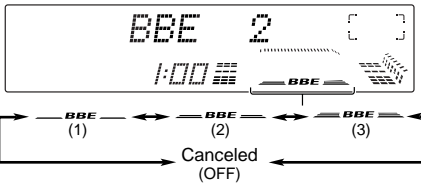
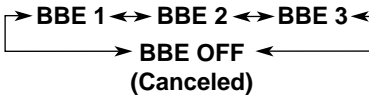

As the number gets higher, the BBE^{II} function becomes stronger.

When shipped from the factory, the BBE^{II} function is set to "BBE 2."

To cancel the BBE^{II} function, select "BBE OFF."

* Under license from BBE Sound, Inc.

BBE^{II} is a trademark of BBE Sound, Inc.

Using the sound control memory

You can select and store a preset sound adjustment suitable for each playback source. (**Advanced SCM**)

Selecting and storing the sound modes

Once you select a sound mode, it is stored in memory. It will be recalled every time you select the same source and will be shown on the display.

A sound mode can be stored for each of the following sources — FM1, FM2, FM3, AM, CD and external components.

- If you do not want to store the sound mode separately for each playback source, but want to use the same sound mode for all the sources, see "To cancel Advanced SCM — SCM LINK" on page 24.

1 Press MODE BAND.

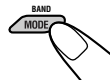

The number buttons can work as different function buttons.



2 Select the sound mode you want.

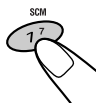

Each time you press the button, the sound mode changes as follows:

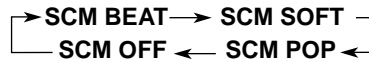

- When "SCM LINK" is set to "SCM LINK ON," the selected sound mode can be stored in memory for the current source and the effect applies only to the current source. Each time you change the playback source, the SCM indicator flashes on the display.
- When "SCM LINK" is set to "SCM LINK OFF," the selected sound mode effect applies to any source.



Indication	For:	Preset values		
		Bass	Treble	BBE ^{II}
SCM BEAT	Rock or disco music	+02	00	2
SCM SOFT	Quiet background music	+01	-03	OFF
SCM POP	Light music	+04	+01	OFF
SCM OFF	(Flat sound)	00	00	2

Recalling the sound modes

When “SCM LINK” is set to “SCM LINK ON,” select the source.



The sound mode stored in memory for the selected source is recalled.



Notes:

- You can adjust each sound mode to your preference, and store it in memory.
If you want to adjust and store your original sound mode, see “Storing your own sound adjustments” on the right column.
- To adjust the bass and treble reinforcement levels or the BBE^{II} function temporarily, see pages 19 and 20. (Your adjustments will be canceled if another source is selected.)

Storing your own sound adjustments

You can adjust the sound modes (SCM BEAT, SCM SOFT, SCM POP) to your preference and store your own adjustments in memory.

- There is a time limit in doing the following procedure. If the setting is canceled before you finish, start from step 1 again.

1 Press MODE BAND.

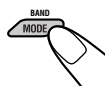

The number buttons can work as different function buttons.

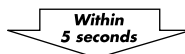

2 Select the sound mode you want.

For details, see page 20.

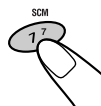

3 1 Select the item you want to adjust (BASS, TREBLE or BBE^{II}).

2 Adjust the selected item.

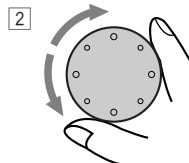
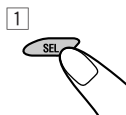

Repeat step 3 to adjust the other items.

4 Press MODE BAND.

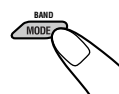

5 Press and hold SCM until the sound mode you have selected flashes on the display.

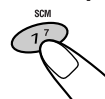

Your adjustment made for the selected sound mode is stored in memory.

6 Repeat the same procedure to adjust other sound modes.

To reset to the factory settings

Repeat the same procedure and reassign the preset values listed in the table on the left column.

Setting the clock

- 1 Press and hold SEL (select) for more than 2 seconds so that one of the PSM items appears on the display. (See page 23.)

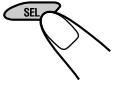

- 2 Set the hour.

- 1 Select "CLOCK HOUR" if not shown on the display.
- 2 Adjust the hour.

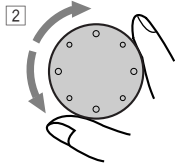
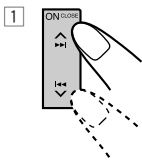

- 3 Set the minute.

- 1 Select "CLOCK MINUTE."
- 2 Adjust the minute.

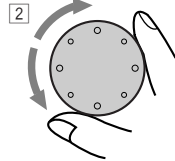
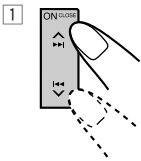

- 4 Set the clock system.

- 1 Select "CLOCK 24H/12H."
- 2 Adjust "CLOCK 24HOUR" or "CLOCK 12HOUR."

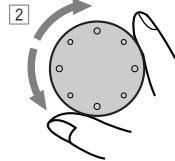
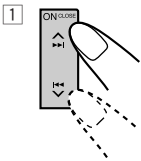

- 5 Press SEL (select) to finish the setting.



Changing the general settings (PSM)

You can change the items listed on the next page by using the PSM (Preferred Setting Mode) control.

Basic Procedure

- 1 Press and hold SEL (select) for more than 2 seconds so that one of the PSM items appears on the display. (See page 23.)

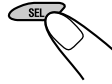

- 2 Select a PSM item you want to adjust. (See page 23.)

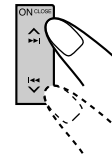

- 3 Adjust the PSM item selected above.

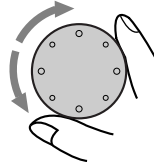

- 4 Repeat steps 2 and 3 to adjust the other PSM items if necessary.

- 5 Press SEL (select) to finish the setting.

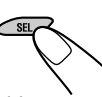
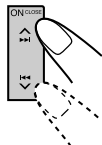
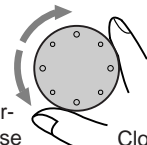

Preferred Setting Mode (PSM) items

<div style="display: flex; justify-content: space-around; align-items: center;"> <div style="text-align: center;"> 1  Hold. </div> <div style="text-align: center;"> 2  Select. </div> <div style="text-align: center;"> 3 Set.  Counter-clockwise Clockwise </div> </div>		Factory-preset settings	See page		
CLOCK HOUR	Hour adjustment	Back	Advance	0:00	22
CLOCK MINUTE	Minute adjustment	Back	Advance		
SCM LINK	Sound control memory linkage	SCM LINK OFF	SCM LINK ON	SCM LINK ON	24
CLOCK24H/12H	24/12-hour time display	CLOCK 12HOUR	CLOCK 24HOUR	CLOCK 24HOUR	22
AUTO ADJUST	Automatic clock setting	ADJUST OFF	ADJUST ON	ADJUST ON	15
CLOCK DISP	Clock display	CLK DISP OFF	CLK DISP ON	CLK DISP ON	24
TUNER DISP	Tuner display	FREQUENCY	PS NAME	PS NAME	15
PTY STANDBY	PTY standby	29 programme types (See pages 13 and 40.)		NEWS	13
PTY SEARCH	PTY search			NEWS	13
TA VOLUME	Traffic announcement volume	VOL 00 – VOL 50		VOL 20	15
P-SEARCH	Programme search	SEARCH OFF	SEARCH ON	SEARCH OFF	14
DAB AF*	Alternative frequency search	AF OFF	AF ON	AF ON	39
LEVEL METER	Level display	4 types (See page 24.)		NORMAL	24
DIMMER MODE	Dimmer mode	DIMMER AUTO ↔ DIMMER OFF ↕ DIMMER ON ↕		DIMMER AUTO	24
CRUISE MODE	Audio cruise	CRUISE 1 ↔ CRUISE 2 ↕ CRUISE OFF ↕		CRUISE OFF	26
+OR– RPM SET**	Idling speed	—		800 rpm	27
BOOST**	Boost	BOOST 01 – 15		BOOST 05	27
TELEPHONE	Telephone muting	MUTING 1 ↔ MUTING 2 ↕ MUTING OFF ↕		MUTING OFF	24
BEEP SWITCH	Key-touch tone	BEEP OFF	BEEP ON	BEEP ON	24
CONTRAST	Display contrast	CONTRAST 01 – 10		CONTRAST 05	25
SCROLL MODE	Scroll mode	SCROLL ONCE ↔ SCROLL AUTO ↕ SCROLL OFF ↕		SCROLL ONCE	25
WOOFER FREQ	Subwoofer cutoff frequency	FREQ LOW ↔ FREQ MID ↕ FREQ HIGH ↕		FREQ MID	25
LINE ADJ	Line input level adjustment	LINE ADJ 00 – 05		LINE ADJ 00	25
FLAT PANEL	Flat panel	FLAT OFF	FLAT ON	FLAT OFF	25
IF FILTER	Intermediate frequency filter	WIDE	AUTO	AUTO	26
DEMO MODE	Demo mode	DEMO OFF	DEMO ON	DEMO ON	26

4 Press SEL (select) to finish the setting.

* Displayed only when the DAB tuner is connected.

** When you select “CRUISE 1” or “CRUISE 2” for Audio Cruise Mode, you can adjust these items.

To cancel Advanced SCM — SCM LINK

You can cancel the Advanced SCM (Sound Control Memory), and unlink the sound modes and the playback sources.

When shipped from the factory, a different sound mode can be stored in memory for each source so that you can change the sound modes simply by changing the sources.

- **SCM LINK ON:** Advanced SCM (different sound modes for different sources)
- **SCM LINK OFF:** Conventional SCM (one sound mode for all sources)

To set the clock display — CLOCK DISP

You can set the clock to be shown on the lower part of the display when the unit is turned on. When shipped from the factory, the clock is set to be shown on the display.

- **CLK DISP ON:** Clock display is turned on.
- **CLK DISP OFF:** Clock display is turned off. When "CLK DISP OFF" is selected, the current sound mode setting (see page 20) is shown on the upper part of the display*.

** If an external source is selected, the current sound mode setting is shown on the lower part of the display.*

To select the level meter — LEVEL METER

You can select the level meter display according to your preference. When shipped from the factory, "NORMAL" is selected.

- **NORMAL:** Normal audio level meter (illuminates from bottom to top)
- **MIRROR:** Level meter illuminates as if it were reflected on a mirror.
- **LEVEL OFF:** Volume level meter stays lit and does not change its illumination.
- **ALL OFF:** Level meter turns off.

To select the dimmer mode — DIMMER MODE

When you turn on the car headlights, the display automatically dims (Auto Dimmer).

When shipped from the factory, Auto Dimmer mode is activated.

- **DIMMER AUTO:** Activates Auto Dimmer.
- **DIMMER OFF:** Cancels Auto Dimmer.
- **DIMMER ON:** Always dims the display.

Note on Auto Dimmer:

Auto Dimmer equipped with this unit may not work correctly on some vehicles, particularly on those having a control dial for dimming.

In this case, set the dimmer mode to "DIMMER ON" or "DIMMER OFF."

To select the telephone muting — TELEPHONE

This mode is used when a cellular phone system is connected. Depending on the phone system used, select either "MUTING 1" or "MUTING 2," whichever mutes the sounds from this unit. When shipped from the factory, this mode is deactivated.

- **MUTING 1:** Select this if this setting can mute the sounds.
- **MUTING 2:** Select this if this setting can mute the sounds.
- **MUTING OFF:** Cancels the telephone muting.

To turn on/off the key-touch tone — BEEP SWITCH

You can deactivate the key-touch tone if you do not want it to beep each time you press a button. When shipped from the factory, the key-touch tone is activated.

- **BEEP ON:** Activates the key-touch tone.
- **BEEP OFF:** Deactivates the key-touch tone.

To adjust the display contrast level — CONTRAST

You can adjust the display contrast level among “01” (dark) to “10” (bright). When shipped from the factory, the display contrast level is set at level “05.”

To select the scroll mode — SCROLL MODE

You can select the scroll mode for the disc information if it consists of more than 12 characters. When shipped from the factory, Auto Scroll mode is set to “SCROLL ONCE.”

- SCROLL ONCE: Scrolls only once.
- SCROLL AUTO: Repeats the scroll (in 5-second intervals).
- SCROLL OFF: Cancels Auto Scroll.

Note:

Even if the scroll mode is set to “SCROLL OFF,” you can scroll the display by pressing *DISP* for more than 1 second.

To select the subwoofer cutoff frequency — WOOFER FREQ

When a subwoofer is connected to this unit, select an appropriate cutoff frequency level for your subwoofer. When shipped from the factory, the subwoofer cutoff frequency is set to “FREQ MID.”

- FREQ LOW: Frequencies higher than 50 Hz are cut off to the subwoofer.
- FREQ MID: Frequencies higher than 80 Hz are cut off to the subwoofer.
- FREQ HIGH: Frequencies higher than 120 Hz are cut off to the subwoofer.

To adjust the line input level — LINE ADJ

Adjust the line input level properly when an external component is connected to the LINE IN plugs. When shipped from the factory, the line input level is set at level “00.”

If the input level of the connected component is not high enough, increase the input level properly. Without adjusting the line input level, you may be surprised at a loud sound when you change from the external component to another source.

To make the front panel look flat (hiding the control panel) — FLAT PANEL

When operating the receiver using the remote control, you can hide the control panel to make the front panel look flat. When shipped from the factory, “FLAT OFF” is selected.

- FLAT ON: The control panel will not come out when you turn on the unit.
To use the control panel, press **◀◀ ▼** so that the control panel comes out. If no operation is done for about 10 seconds, it automatically goes back into the receiver.
- FLAT OFF: You can use the control panel normally.

Note:

When “FLAT ON” is selected, you can eject a CD by holding **▶▶ ▼**.

To change the FM tuner selectivity — IF FILTER

In some areas, adjacent stations may interfere with each other. If this interference occurs, noise may be heard. This unit has been preset to automatically reduce this interference noise ("AUTO") when shipped from the factory.

- **AUTO:** When this type of interference occurs, this unit automatically increases the tuner selectivity so that interference noise will be reduced. (But the stereo effect will also be lost.)
- **WIDE:** Subject to the interference from adjacent stations, but sound quality will not be degraded and the stereo effect will not be lost.

To turn the demo mode on or off — DEMO MODE

You can turn the demo mode on or off. When shipped from the factory, "DEMO ON" is selected.

- **DEMO ON:** Turns the demo mode on. The demonstration will start automatically if no sound comes in for 3 minutes.
- **DEMO OFF:** Turns the demo mode off.

Note:

If the unit has been reset (and the power is on), demonstration will start if no sound comes in for about 10 seconds.

Controlling the volume automatically (Audio Cruise)

You can select the proper cruise mode for your car.

This unit changes the volume level automatically (at 3 possible levels) based on the driving speed of your car by detecting the alternator's generating frequency (Audio Cruise).

If you want to use this mode, follow the procedure below. When shipped from the factory, this mode is set to "CRUISE OFF."

- **CRUISE 1:** Select this if your car is relatively quiet.
- **CRUISE 2:** Select this if your car is relatively loud. The volume increase rate is twice as much as that of the CRUISE 1 setting.
- **CRUISE OFF:** Cancels Audio Cruise.

- 1 Press and hold SEL (select) for more than 2 seconds so that one of the PSM items appears on the display. (See page 23.)**



- 2 Select "CRUISE MODE."**

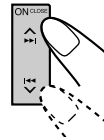

- 3 Select the desired setting.**

As you turn the control dial, the Audio Cruise mode changes as follows:

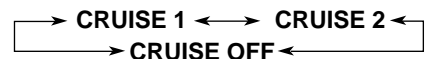
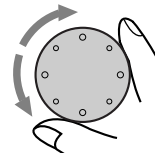

4 Press SEL (select) to finish the setting.



When this function is turned on (the CRUISE indicator lights up on the display), the proper volume level is automatically selected among the 3 possible levels according to the driving speed, and the selected level is shown on the display.

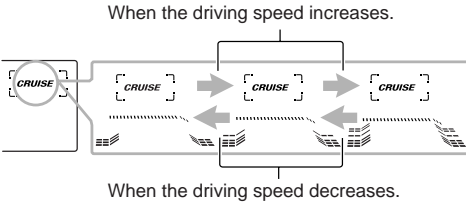

To adjust the volume increase rate

If you find Audio Cruise increases (or decreases) the volume either too much or too little as the driving speed changes, you can adjust the increase rate by changing the boost level. To change it, follow the procedure below.

- 1 Press and hold SEL (select) for more than 2 seconds so that one of the PSM items appears on the display.
- 2 Press ▲▶▶| or |◀◀▼ repeatedly until "CRUISE MODE" appears on the display.
- 3 Turn the control dial to select either "CRUISE 1" or "CRUISE 2."
- 4 Press ▲▶▶| (or |◀◀▼) to select "BOOST." The current boost level also appears on the display.
- 5 Turn the control dial to select the desired boost level (among 01 to 15).
- 6 Press SEL (select) to finish the setting.

If Audio Cruise does not function correctly

You may need to store the idling speed into memory to make Audio Cruise function correctly.

NOTICE that a number of factors, such as electric power steering, wipers, power windows, air conditioner, etc. do generate noises and, as a result, may cause Audio Cruise not to function correctly. If this is the main cause of malfunction, connect the memory backup lead (yellow lead) directly to the car battery to prevent these noises from affecting Audio Cruise.

- 1 Start the engine and let it warm up.
- 2 Press and hold SEL (select) for more than 2 seconds so that one of the PSM items appears on the display.
- 3 Press ▲▶▶| or |◀◀▼ repeatedly until "CRUISE MODE" appears on the display.
- 4 Turn the control dial to select either "CRUISE 1" or "CRUISE 2."
- 5 Press ▲▶▶| (or |◀◀▼) to select "+OR-RPM SET."
- 6 Turn the control dial to select the desired idling speed.
- 7 Press SEL (select) to finish the setting.

When the setting is complete, the unit automatically checks to see if Audio Cruise functions correctly with this new idling setting. If it does not function correctly, Audio Cruise is canceled automatically and the idling setting becomes invalid.

- *If this happens, see the NOTICE above.*

Assigning names to the sources

You can assign names to CDs and the external component connected to the LINE IN plugs. After assigning a name, it will appear on the display when you select the source.

Sources	Maximum number of the characters
CDs* and CD changer*	Up to 32 characters (up to 40 discs)
External component	Up to 12 characters

* You cannot assign a name to a CD Text.

1 Select a source you want to assign a name to.



2 Press and hold SEL (select) for more than 2 seconds while pressing DISP.

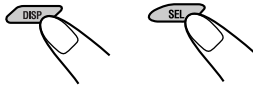

When you select the CD as the source:

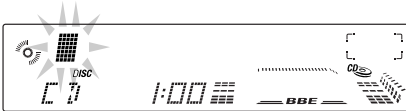

When you select the external component connected to LINE IN as the source:

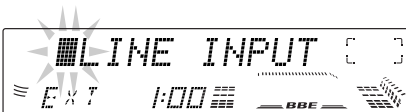

3 Select the character set you want while " " is flashing.

Each time you press the button, the character set changes as follows:

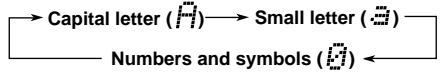
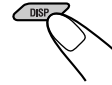

4 Select a character.

About the available characters, see page 29.

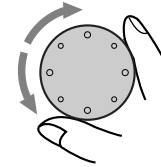

5 Move the cursor to the next (or previous) character position.

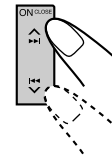

6 Repeat steps 3 to 5 until you finish inputting the name.

7 Press the button while the last selected character is flashing.

The input name is stored in memory.



To erase the input characters

Insert spaces using the same procedure described above.

Available characters

Capital letters

A	B	C	D	E	F	G	H	I	J
K	L	M	N	O	P	Q	R	S	T
U	V	W	X	Y	Z	space			

Small letters

a	b	c	d	e	f	g	h	i	j
k	l	m	n	o	p	q	r	s	t
u	v	w	x	y	z	space			

Numbers and symbols

0	1	2	3	4	5	6	7	8	9
!	"	#	\$	%	&	'	()	*
+	,	-	.	/	:	;	<	=	>
?	@	_	`	space					

Notes:

- When you try to assign a name to the 41st disc, "NAME FULL" appears on the display. (In this case, delete unwanted names before assignment.)
- When the CD changer is connected, you can assign names to CDs in the CD changer. These names can also be shown on the display if you insert the CDs in this unit.



Using the security lock

You can prohibit the unauthorized use of this unit by the others.

To use the security lock, you need to set the password first. Once you set the password, the unit will ask you to enter the password when you turn on the unit for the first time after re-installation (or after recovering the car battery exhaustion).

CAUTION: Be careful not to forget the password you have entered; otherwise, you cannot use this unit. Keep the password in your mind and more importantly on paper or some other materials. You can write down your password in the spaces provided on the cover page.

Registering the password

You have to use 4 characters for your password. You can use the following characters: Capital letters (A – Z), small letters (a – z) and numbers (0 – 9).

- 1 Press and hold both buttons for more than 2 seconds.

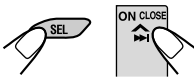

The unit enters password entry mode.

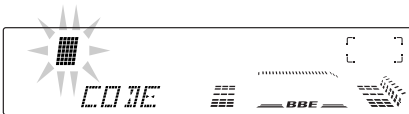

- 2 Select the character set you want to use.



Each time you press the button, the character set changes as follows:

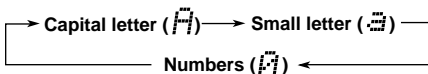

- 3 Select a letter.

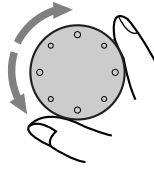

- 4 Move the character entry position to the next.

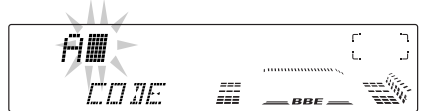
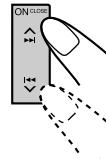

- 5 Repeat steps 2 to 4 until you enter all 4 characters.

- 6 Press SEL (select) to finish the setting.



The password flashes on the display for a while, then the unit returns to the normal operation mode.

How to Use the Provided CODE Sticker

Attach the provided CODE sticker in a conspicuous position on your car to notify would-be unauthorized users that the security lock function is provided for this unit and, therefore, will foil their efforts.

When Security Lock works?

Once you register the password, “*:*:*:*:” appears on the display, and the unit will ask you to enter the password in the following cases:

- When you turn on the unit for the first time after re-installing the unit.
- When you turn on the unit for the first time after replacing the car battery.

To use this unit, you must enter the correct password by following the procedure below.

1 Press DISP (display) to select the character set you want.



2 Turn the control dial to enter a character.

3 Press   or   to move the character entry position.

4 Repeat steps 1 to 3 to enter the entire password (4 letters) correctly, then press SEL (select).



- If you enter the correct password, the security lock is canceled and you can use the unit normally.
- In the following cases, the security lock is not canceled (“NOT ACCEPT” appears on the display) then the unit turns off. (The unit will never turn on unless you press the reset button on the front panel. See page 2.)
 - If you enter an incorrect password then press SEL (select).
 - If you cannot finish entering the correct password within 30 seconds.

If you enter an incorrect character while entering the password

Press   to move back the character entry position over the incorrect character; then repeat steps 1 and 2 to select the correct character.

To change the password

If you want to change the password after you have registered it, follow the procedure below.

1 Press SEL (select) and   at the same time for more than 2 seconds.

“*:*:*:*:” appears on the display.

2 Enter the current password correctly, then press SEL (select).

The unit enters password entry mode.

3 Enter a new password as you want, then press SEL (select).

The password flashes on the display for a while, then the unit returns to the normal operation mode.

- See page 30 for details on how to enter the password.



CD CHANGER OPERATIONS

ENGLISH

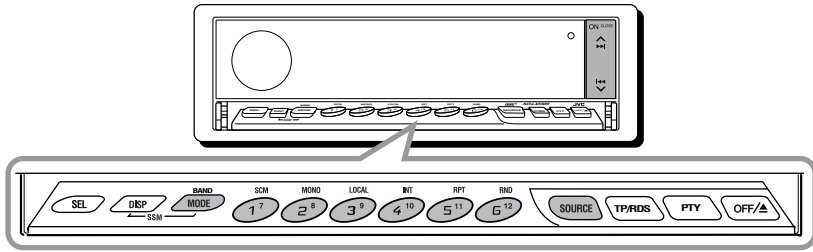

We recommend that you use one of the CH-X series with your unit.

If you have another CD automatic changer, consult your JVC IN-CAR ENTERTAINMENT dealer for connections.

- For example, if your CD automatic changer is one of the KD-MK series, you need a cord (KS-U15K) for connecting it to this unit.

Before operating your CD automatic changer:

- Refer also to the Instructions supplied with your CD changer.
- If no discs are in the magazine of the CD changer or the discs are inserted upside down, "NO DISC" will appear on the display. If this happens, remove the magazine and set the discs correctly.
- If "RESET 1" – "RESET 8" appears on the display, something is wrong with the connection between this unit and the CD changer. If this happens, check the connection, connect the connecting cord(s) firmly if necessary, then press the reset button of the CD changer.

Playing CDs

Select the CD automatic changer.

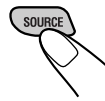

Each time you press the button, the source changes as described on page 7.

Playback starts from the first track of the first disc.

All tracks of all discs are played back.

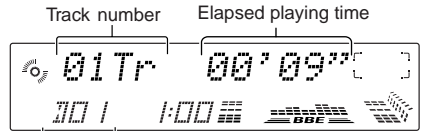

Disc number appears.

To fast-forward or reverse the track

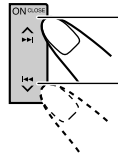

Press and hold **▶▶▶**, while playing a CD, to fast-forward the track.

Press and hold **◀◀◀**, while playing a CD, to reverse the track.

To go to the next track or the previous tracks

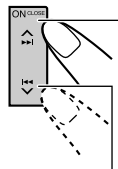

Press **▶▶▶** briefly, while playing a CD, to go ahead to the beginning of the next track. Each time you press the button consecutively, the beginning of the next track is located and played back.

Press **◀◀◀** briefly, while playing a CD, to go back to the beginning of the current track. Each time you press the button consecutively, the beginning of the previous tracks is located and played back.

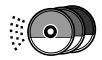

To go to a particular disc directly

Press the number button corresponding to the disc number to start its playback (while the CD changer is playing).

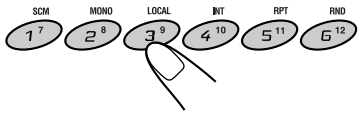

- To select a disc number from 1 – 6: Press 1 (7) – 6 (12) briefly.
- To select a disc number from 7 – 12: Press and hold 1 (7) – 6 (12) for more than 1 second.

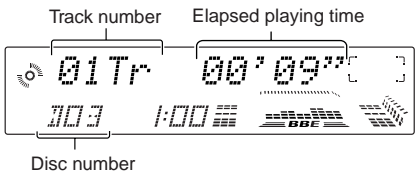

Ex.: When disc number 3 is selected

To show the CD Text information

This is possible only when connecting a JVC CD automatic changer equipped with CD Text reading capability. See "Playing a CD Text" on page 18.

Selecting CD playback modes

- There is a time limit in doing the following procedure. If the setting is cancelled before you finish, start from step 1 again.

To play back tracks at random (Random Play)

1 Press MODE BAND while playing a CD. "MODE" appears on the display.

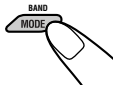

2 Press RND (random), while "MODE" is still on the display, so that the RND indicator lights up on the display. Each time you press the button, CD random play mode changes as follows:

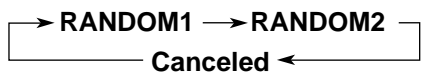
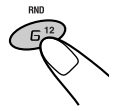

Mode	RND Indicator	Plays at random
RANDOM1	Lights	All tracks of the current disc, then the tracks of the next disc, and so on.
RANDOM2	Flashes	All tracks of all discs inserted in the magazine.



To play back tracks repeatedly (Repeat Play)

1 Press MODE BAND while playing a CD.
"MODE" appears on the display.

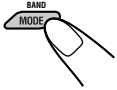

Within 5 seconds

2 Press RPT (repeat), while "MODE" is still on the display, so that the RPT indicator lights up on the display.
Each time you press the button, CD repeat play mode changes as follows:

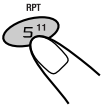

Mode	RPT Indicator	Plays repeatedly
REPEAT1	Lights	The current track (or specified track).
REPEAT2	Flashes	All tracks of the current disc (or specified disc).

To play back only intros (Intro Scan)

1 Press MODE BAND while playing a CD.
"MODE" appears on the display.

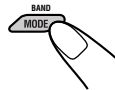

Within 5 seconds

2 Press INT (intro), while "MODE" is still on the display.
Each time you press the button, CD intro scan mode changes as follows:

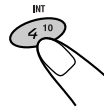

Mode	Indication	Plays the beginnings (15 seconds)
INTRO1	Track number flashes	Of all tracks on all inserted discs.
INTRO2	Disc number flashes (when it is shown on the display)	Of the first track on each inserted disc.

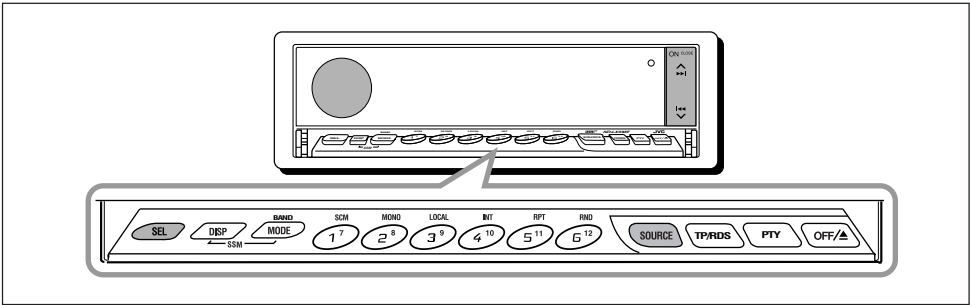

Playing an external component

When connecting an external component to the LINE IN plugs on the rear, you can select the component as the sound source.

1 Select the external component.



Each time you press the button, the source changes as described on page 7.

2 Operate the external component.

Note:

For the external component connection, see the *Installation/Connection Manual* (separate volume).

Using a subwoofer

By connecting a subwoofer to the SUBWOOFER OUT plugs on the rear, you can enjoy enhanced bass sounds and a more realistic theater atmosphere in your car.

- Refer also to the instructions supplied with your subwoofer.

When a subwoofer is connected to this unit, select an appropriate cutoff frequency level for your subwoofer.

To set the subwoofer cutoff frequency, see “To select the subwoofer cutoff frequency — WOOFER FREQ” on page 25.

To adjust the subwoofer output volume, see “Adjusting the sound” on page 19.

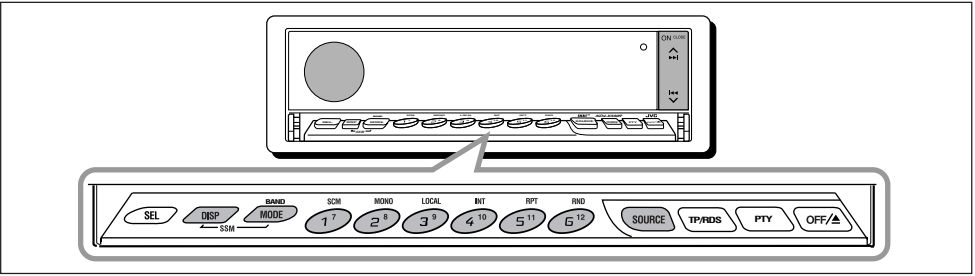

We recommend that you use DAB (Digital Audio Broadcasting) tuner KT-DB1500 with your unit. If you have another DAB tuner, consult your JVC IN-CAR ENTERTAINMENT dealer.

- Refer also to the Instructions supplied with your DAB tuner.

What is DAB system?

DAB is one of the digital radio broadcasting systems available today. It can deliver CD quality sound without any annoying interference and signal distortion. Furthermore, it can carry text, pictures and data. In contrast to FM broadcast, where each programme is transmitted on its own frequency, DAB combines several programmes (called “services”) to form one “ensemble.” With the DAB tuner connected with this unit, you can enjoy these DAB services.

Tuning into an ensemble and one of the services

A typical ensemble has 6 or more programmes (services) broadcast at the same time. After tuning into an ensemble, you can select a service you want to listen to.

1 Select the DAB tuner (DAB1–3).

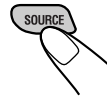

2 Select the DAB band (DAB1, DAB2, or DAB3).

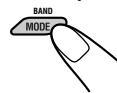

Each time you press and hold the button, the DAB band changes as follows:



Note:

This receiver has three DAB bands (DAB1, DAB2, DAB3). You can use any of them to tune into an ensemble.

3 Start searching an ensemble.

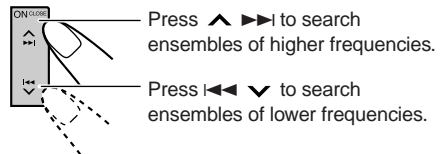

When an ensemble is received, searching stops.

To stop searching before an ensemble is received, press the same button you have pressed for searching.

4 Select a service you want to listen to.

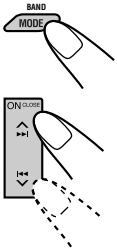

- 1 Press MODE BAND. "MODE" appears on the display.
- 2 Press \blacktriangle \blacktriangleright or \blacktriangleleft \blacktriangledown to select a service you want, while "MODE" is still on the display.

To change the display information while tuning into an ensemble

Normally service name is shown on the display. If you want to check the ensemble name or its frequency, press DISP (display). Each time you press the button, the following information appears for a while on the display.

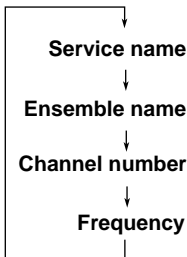

To tune in a particular ensemble without searching:

- 1 Press SOURCE to select DAB tuner as the source.
- 2 Press MODE BAND repeatedly to select the DAB band (DAB1, DAB2, or DAB3).
- 3 Press and hold \blacktriangle \blacktriangleright or \blacktriangleleft \blacktriangledown for more than 1 second.
- 4 Press \blacktriangle \blacktriangleright or \blacktriangleleft \blacktriangledown repeatedly until the ensemble you want is reached.
 - If you hold down the button, the ensemble keeps changing until you release the button.

Storing DAB services in memory

You can preset up to 6 DAB services in each DAB band (DAB1, DAB2 and DAB3) manually.

1 Select the DAB tuner (DAB1–3).

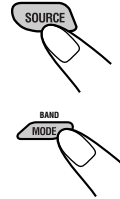

- 1 Press SOURCE to select DAB tuner as the source.
- 2 If necessary, press and hold MODE BAND repeatedly to select the DAB band number (DAB1, DAB2 or DAB3).

Each time you press and hold the button, the DAB band changes as follows:



2 Tune into an ensemble you want.

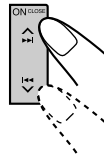

3 Select a service of the ensemble you want.

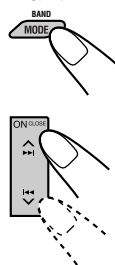

- 1 Press MODE BAND. "MODE" appears on the display.
- 2 Press \blacktriangle \blacktriangleright or \blacktriangleleft \blacktriangledown to select a service you want, while "MODE" is still on the display.

CONTINUED ON THE NEXT PAGE

4 Press and hold the number button (in this example, 1) you want to store the selected service into for more than 2 seconds.

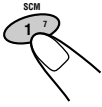

Band number and "MEMO" appear alternately for a while.

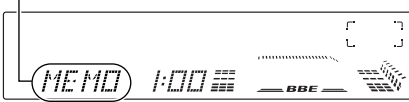

5 Repeat the above procedure to store other DAB services into other preset numbers.

Notes:

- A previously preset DAB service is erased when a new DAB service is stored in the same preset number.
- Preset DAB services are erased when the power supply to the memory circuit is interrupted (for example, during battery replacement). If this occurs, preset the DAB services again.

Tuning into a preset DAB service

You can easily tune into a preset DAB service. Remember that you must store services first. If you have not stored them yet, see page 37.

1 Select the DAB tuner (DAB1–3).

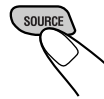

1 Press SOURCE to select DAB tuner as the source.

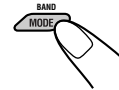

2 If necessary, press and hold MODE BAND repeatedly to select the DAB band number (DAB1, DAB2 or DAB3).

Each time you press and hold the button, the DAB band changes as follows:



2 Select the number (1 – 6) for the preset DAB service you want.

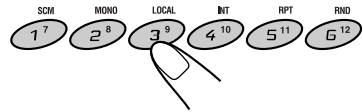

What you can do more with DAB

Tracing the same program automatically (Alternative Reception)

You can keep listening to the same program.

- **While receiving a DAB service:**

When driving in an area where a service cannot be received, this unit automatically tunes in another ensemble or FM RDS station, broadcasting the same program.

- **While receiving an FM RDS station:**

When driving in an area where a DAB service is broadcasting the same program as the FM RDS station is broadcasting, this unit automatically tunes into the DAB service.

Note:

When reception switches between DAB and FM, the listening volume level may increase or decrease inconveniently. This change in the volume level results from unequal audio injection levels at broadcaster site, but not from the malfunction of this unit.

To use Alternative Reception

When shipped from the factory, Alternative Reception is activated.

- 1 Press and hold SEL (select) for more than 2 seconds so that one of the PSM items appears on the display.
- 2 Press **▲ ►►** or **◄◄ ▼** to select "DAB AF" (alternative frequency).
- 3 Turn the control dial to select the desired mode.
 - AF ON: Traces the program among DAB services and FM RDS stations — Alternative Reception. The AF indicator lights up on the display (see page 11).
 - AF OFF: Deactivates Alternative Reception

Note:

When Alternative Reception (for DAB services) is activated, Network-Tracking Reception (for RDS stations: see page 11) is also activated automatically. On the other hand, Network-Tracking Reception cannot be deactivated without deactivating Alternative Reception.

- 4 Press SEL (select) to finish the setting.

ADDITIONAL INFORMATION

PTY codes

NEWS:	News	SOCIAL:	Programmes on social activities
AFFAIRS:	Topical programmes expanding on current news or affairs	RELIGION:	Programmes dealing with any aspect of belief or faith, or the nature of existence or ethics
INFO:	Programmes which impart advice on a wide variety of topics	PHONE IN:	Programmes where people can express their views either by phone or in a public forum
SPORT:	Sport events	TRAVEL:	Programmes about travel destinations, package tours, and travel ideas and opportunities
EDUCATE:	Educational programmes	LEISURE:	Programmes concerned with recreational activities such as gardening, cooking, fishing, etc.
DRAMA:	Radio plays	JAZZ:	Jazz music
CULTURE:	Programmes on national or regional culture	COUNTRY:	Country music
SCIENCE:	Programmes on natural science and technology	NATION M:	Current popular music from another nation or region, in that country's language
VARIED:	Other programmes like comedies or ceremonies	OLDIES:	Classic pop music
POP M:	Pop music	FOLK M:	Folk music
ROCK M:	Rock music	DOCUMENT:	Programmes dealing with factual matters, presented in an investigative style
EASY M:	Easy-listening music		
LIGHT M:	Light music		
CLASSICS:	Classical music		
OTHER M:	Other music		
WEATHER:	Weather information		
FINANCE:	Reports on commerce, trading, the Stock Market, etc.		
CHILDREN:	Entertainment programmes for children		



What appears to be trouble is not always serious. Check the following points before calling a service centre.

Symptoms	Causes	Remedies
<ul style="list-style-type: none"> CD cannot be played back. 	CD is inserted upside down.	Insert the CD correctly.
<ul style="list-style-type: none"> CD sound is sometimes interrupted. 	You are driving on rough roads.	Stop CD play while driving on rough roads.
	CD is scratched.	Change the CD.
	Connections are incorrect.	Check the cords and connections.
<ul style="list-style-type: none"> Sound cannot be heard from the speakers. 	The volume level is set to the minimum level.	Adjust it to the optimum level.
	Connections are incorrect.	Check the cords and connections.
<ul style="list-style-type: none"> SSM (Strong-station Sequential Memory) automatic preset does not work. 	Signals are too weak.	Store stations manually.
<ul style="list-style-type: none"> Static noise while listening to the radio. 	The antenna is not connected firmly.	Connect the antenna firmly.
<ul style="list-style-type: none"> “NO DISC” appears on the display. 	No CD is in the magazine.	Insert CD.
<ul style="list-style-type: none"> “RESET 8” appears on the display. 	This unit is not connected to a CD changer correctly.	Connect this unit and the CD changer correctly and press the reset button of the CD changer.
<ul style="list-style-type: none"> “RESET 1” – “RESET 7” appears on the display. 	_____	Press the reset button of the CD changer.
<ul style="list-style-type: none"> “EJECT ERROR” appears on the display and CD cannot be ejected. 	The CD player may function incorrectly.	Press and hold I◀◀ ▼ for more than 5 seconds.
<ul style="list-style-type: none"> No message appears on the display but CD cannot be ejected. 		While holding ▲▶▶I , press the reset button. Release the reset button, then release ▲▶▶I . (Be careful not to drop the CD when ejecting.)
<ul style="list-style-type: none"> “⋄⋄⋄⋄⋄” appears on the display. 	Security lock is in use.	Enter the password. (See page 31.)
<ul style="list-style-type: none"> This unit does not work at all. The CD changer does not work at all. 	The built-in microcomputer may function incorrectly due to noise, etc.	Press the reset button on the front panel. (See page 2.)



Handling CDs

This unit has been designed to reproduce the CDs bearing the following marks.



You can play back your original CD-Rs (Recordable) and CD-RWs (Rewritable) on this receiver.

This unit is not compatible with MP3.

How to handle CDs

When removing a CD from its case, press down the center holder of the case and lift the CD out, holding it by the edges.

- Always hold the CD by the edges. Do not touch its recording surface.

When storing a CD into its case, gently insert the CD around the center holder (with the printed surface facing up).

- Make sure to store CDs into the cases after use.

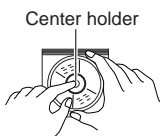

To keep CDs clean

A dirty CD may not play correctly. If a CD does become dirty, wipe it with a soft cloth in a straight line from center to edge.



To play new CDs

New CDs may have some rough spots around the inner and outer edges. If such a CD is used, this unit may reject the CD.

To remove these rough spots, rub the edges with a pencil or ball-point pen, etc.

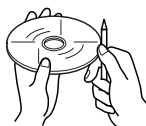

About mistracking:

Mistracking may result from driving on extremely rough roads. This does not damage the unit and the CD, but will be annoying.

We recommend that you stop CD play while driving on such rough roads.

Moisture condensation

Moisture may condense on the lens inside the CD player in the following cases:

- After starting the heater in the car.
- If it becomes very humid inside the car.

Should this occur, the CD player may malfunction. In this case, eject the CD and leave the unit turned on for a few hours until the moisture evaporates.

When playing a CD-R or CD-RW

User-edited CD-Rs (Recordable) and CD-RWs (Rewritable) can be played back only if they are already "finalized."

- You can play back your original CD-Rs or CD-RWs recorded in music CD format. (However, they may not be played back depending on their characteristics or recording conditions.)
- Before playing back CD-Rs or CD-RWs, read their instructions or cautions carefully.
- Some CD-Rs or CD-RWs may not be played back on this unit because of their disc characteristics, damage or stain on them, or if the player's lens is dirty.
- CD-Rs or CD-RWs are susceptible to high temperatures or high humidity; so do not leave them inside your car.
- CD-RWs may require a longer readout time. (This is caused by the fact that the reflectance of CD-RWs is lower than for regular CDs.)

CAUTIONS:

- Do not insert 8 cm CDs (single CDs) into the loading slot. (Such CDs cannot be ejected.)
- Do not insert any CD of unusual shape – like a heart or flower; otherwise, it will cause a malfunction.
- Do not expose CDs to direct sunlight or any heat source or place them in a place subject to high temperature and humidity. Do not leave them in a car.
- Do not use any solvent (for example, conventional record cleaner, spray, thinner, benzene, etc.) to clean CDs.

AUDIO AMPLIFIER SECTION

Maximum Power Output:

Front: 50 W per channel

Rear: 50 W per channel

Continuous Power Output (RMS):

Front: 19 W per channel into 4 Ω , 40 Hz to 20 000 Hz at no more than 0.8% total harmonic distortion.

Rear: 19 W per channel into 4 Ω , 40 Hz to 20 000 Hz at no more than 0.8% total harmonic distortion.

Load Impedance: 4 Ω (4 Ω to 8 Ω allowance)

Tone Control Range:

Bass: ± 10 dB at 100 Hz

Treble: ± 10 dB at 10 kHz

Frequency Response: 40 Hz to 20 000 Hz

Signal-to-Noise Ratio: 70 dB

Line-In Level/Impedance:

1.5 V/20 k Ω load

Line-Out Level/Impedance:

4.0 V/20 k Ω load (full scale)

Output Impedance: 1 k Ω

TUNER SECTION

Frequency Range:

FM: 87.5 MHz to 108.0 MHz

AM: (MW) 522 kHz to 1 620 kHz

(LW) 144 kHz to 279 kHz

[FM Tuner]

Usable Sensitivity: 11.3 dBf (1.0 μ V/75 Ω)

50 dB Quieting Sensitivity:

16.3 dBf (1.8 μ V/75 Ω)

Alternate Channel Selectivity (400 kHz):

65 dB

Frequency Response: 40 Hz to 15 000 Hz

Stereo Separation: 30 dB

Capture Ratio: 1.5 dB

[MW Tuner]

Sensitivity: 20 μ V

Selectivity: 35 dB

[LW Tuner]

Sensitivity: 50 μ V

CD PLAYER SECTION

Type: Compact disc player

Signal Detection System: Non-contact optical pickup (semiconductor laser)

Number of channels: 2 channels (stereo)

Frequency Response: 5 Hz to 20 000 Hz

Dynamic Range: 96 dB

Signal-to-Noise Ratio: 98 dB

Wow and Flutter: Less than measurable limit

GENERAL

Power Requirement:

Operating Voltage: DC 14.4 V
(11 V to 16 V allowance)

Grounding System: Negative ground

Allowable Operating Temperature:
0°C to +40°C

Dimensions (W \times H \times D):

Installation Size:
182 mm \times 52 mm \times 160 mm

Panel Size:

188 mm \times 58 mm \times 8 mm

Mass: 1.8 kg (excluding accessories)

Design and specifications subject to change without notice.

Having TROUBLE with operation?

Please reset your unit

Refer to page of How to reset your unit

Haben Sie PROBLEME mit dem Betrieb?

Bitte setzen Sie Ihr Gerät zurück

Siehe Seite Zurücksetzen des Geräts

Vous avez des PROBLÈMES de fonctionnement?

Réinitialisez votre appareil

Référez-vous à la page intitulée Comment réinitialiser votre appareil

Hebt u PROBLEMEN met de bediening?

Stel het apparaat terug

Zie de pagina met de paragraaf Het apparaat terugstellen

JVC

VICTOR COMPANY OF JAPAN, LIMITED

JVC



ENGLISH

DEUTSCH

FRANÇAIS

NEDERLANDS

CD RECEIVER
CD-RECEIVER
RECEPTEUR CD
CD-RECEIVER

KD-LX110R

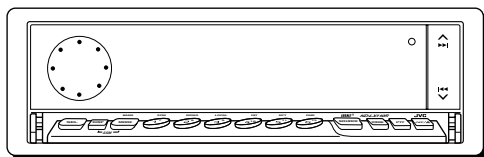
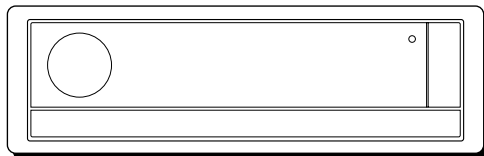

BBE^{II}

For installation and connections, refer to the separate manual.

Angaben zu Einbau und Verkabelung entnehmen Sie bitte der gesonderten Anleitung.

Pour l'installation et les raccordements, se référer au manuel séparé.

Zie de afzonderlijke handleiding voor details aangaande het installeren en verbinden van het toestel.

INSTRUCTIONS

BEDIENUNGSANLEITUNG
MANUEL D'INSTRUCTIONS
GEBRUIKSAANWIJZING

For Customer Use:

Enter below the password you have entered for your security lock.

Retain this password for future reference.

PASSWORD:

PIM164100

[E]

Position And Reproduction Of Labels

Bottom panel of the main unit

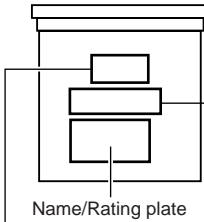

CAUTION: Invisible laser radiation when open and interlock failed or defeated. AVOID DIRECT EXPOSURE TO BEAM.	ADVARSEL: Usynlig laserstråling ved åbning, når sikkerhedsafbrydere er ude af funktion. Undgåudsættelse for stråling. (e)	WARNING: Osynlig laserstråling när denna del är öppnad och spärren är urkopplad. Betrakta ej strålen. (d)	VARO: Avattaessa ja suojalukitus ohitettaessa olet alttiina näkymättömälle lasersäteilylle. Älä katso säteeseen. (f)
---	--	--	---

IMPORTANT FOR LASER PRODUCTS

Precautions:

1. CLASS 1 LASER PRODUCT

- CAUTION:** Invisible laser radiation when open and interlock failed or defeated. Avoid direct exposure to beam.
- CAUTION:** Do not open the top cover. There are no user-serviceable parts inside. Leave all servicing to qualified service personnel.
- CAUTION:** This CD player uses invisible laser radiation and is equipped with safety switches to prevent radiation emission when unloading CDs. It is dangerous to defeat the safety switches.
- CAUTION:** Use of controls, adjustments or performance of procedures other than those specified herein may result in hazardous radiation exposure.

**CLASS 1
LASER PRODUCT**

Caution:

This product contains a laser component of higher laser class than Class 1.

How to reset your unit

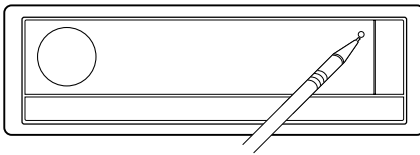

Press the reset button on the front panel using a ball-point pen or a similar tool. This will reset the built-in microcomputer.

Note:

Your preset adjustments — such as preset channels or sound adjustments — will also be erased.

Note:

For security reasons, a numbered ID card is provided with this unit, and the same ID number is imprinted on the unit's chassis. Keep the card in a safe place, as it will help the authorities to identify your unit if stolen.

CAUTION on Volume Setting

CDs produce very little noise compared with other sources. If the volume level is adjusted for the tuner, for example, the speakers may be damaged by the sudden increase in the output level. Therefore, lower the volume before playing a disc and adjust it as required during playback.

Thank you for purchasing a JVC product. Please read all instructions carefully before operation, to ensure your complete understanding and to obtain the best possible performance from the unit.

CONTENTS

LOCATION OF THE BUTTONS	4	OTHER MAIN FUNCTIONS	22
Control panel	4	Setting the clock	22
Remote controller (With an optionally purchased remote controller)	5	Changing the general settings (PSM)	22
Preparing the remote controller	6	Assigning names to CDs	26
		Using the security lock	27
BASIC OPERATIONS	7	CD CHANGER OPERATIONS	29
		Playing CDs	29
RADIO BASIC OPERATIONS	8	Selecting CD playback modes	30
Listening to the radio	8	EXTERNAL COMPONENT OPERATIONS ...	32
Storing stations in memory	9	Playing an external component	32
Tuning into a preset station	10	DAB TUNER OPERATIONS	33
RDS OPERATIONS	11	Tuning into an ensemble and one of the services	33
What you can do with RDS EON	11	Storing DAB services in memory	34
Other convenient RDS functions and adjustments	14	Tuning into a preset DAB service	35
		What you can do more with DAB	36
CD OPERATIONS	16	ADDITIONAL INFORMATION	36
Playing a CD	16	TROUBLESHOOTING	37
Locating a track or a particular portion on a CD	17	MAINTENANCE	38
Selecting CD playback modes	17	Handling CDs	38
Prohibiting CD ejection	18	SPECIFICATIONS	39
Playing a CD Text	18		
SOUND ADJUSTMENTS	19		
Adjusting the sound	19		
Using the sound control memory	20		
Storing your own sound adjustments	21		

About the demonstration mode (DEMO MODE)...

When shipped from the factory, "DEMO MODE" is set to "DEMO ON" in this unit. The demonstration will start automatically if no sound comes in for 3 minutes. (See page 25.)

To activate the display demonstration manually

While holding DISP, press **▲ ►►** until "DEMO" appears on the display.

Various functions and display illumination modes equipped with this unit will be demonstrated repeatedly in sequence. During the display demonstration, "DEMO" flashes on the display.

To turn off the display demonstration, press **▲ ►►** again for a few seconds while holding DISP.

- The display demonstration will turn off automatically after about 1 hour.

BEFORE USE

*For safety...

- Do not raise the volume level too much, as this will block outside sounds, making driving dangerous.
- Stop the car before performing any complicated operations.

*Temperature inside the car...

If you have parked the car for a long time in hot or cold weather, wait until the temperature in the car becomes normal before operating the unit.



LOCATION OF THE BUTTONS

ENGLISH

Control panel

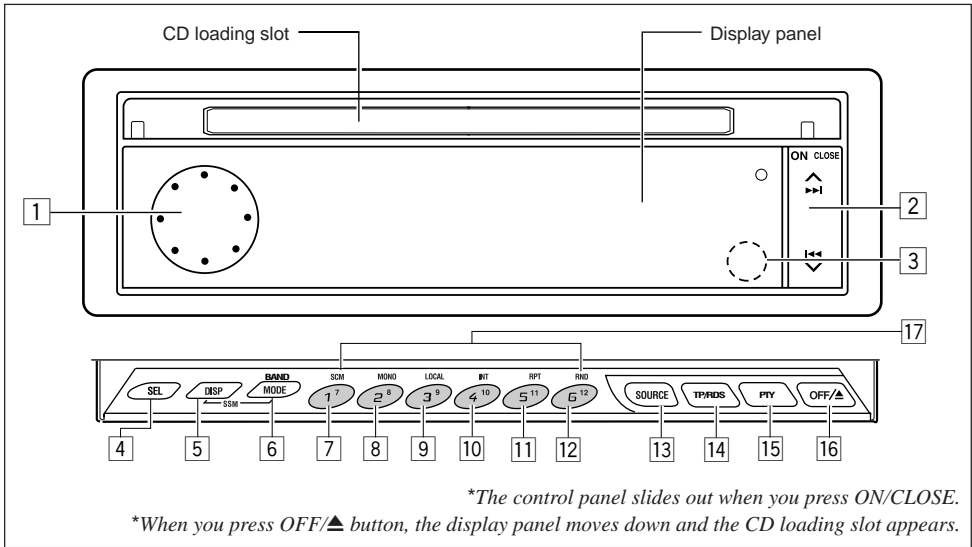

- | | |
|---|---|
| <ul style="list-style-type: none"> 1 Control dial 2 ▲▶▶/◀◀▼ button <ul style="list-style-type: none"> • ▲▶▶/◀◀▼ also functions as ON or CLOSE button. 3 Remote sensor 4 SEL (select) button 5 DISP (display) button <ul style="list-style-type: none"> • Also functions as SSM buttons when pressed together with the MODE BAND button. 6 MODE BAND button <ul style="list-style-type: none"> • Also functions as SSM buttons when pressed together with the DISP button. | <ul style="list-style-type: none"> 7 SCM (sound control memory) button 8 MONO button 9 LOCAL button 10 INT (intro) button 11 RPT (repeat) button 12 RND (random) button 13 SOURCE button 14 TP (traffic programme)/RDS (radio data system) button 15 PTY (programme type) button 16 OFF/▲ (eject) button 17 Number buttons |
|---|---|

How to use the number buttons:

After pressing MODE BAND, the number buttons work as different function buttons (while "MODE" remains on the display).

To use these buttons as number buttons after pressing MODE BAND, wait for 5 seconds without pressing any number button so that "MODE" disappears from the display.

- Pressing MODE BAND again also erases "MODE" from the display.

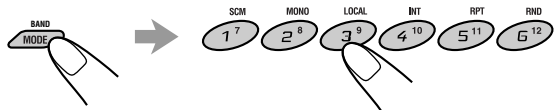



Remote controller

(With an optionally purchased remote controller)

We recommend that you use remote controller RM-RK31 with your unit.

The following are the instructions for using RM-RK31.

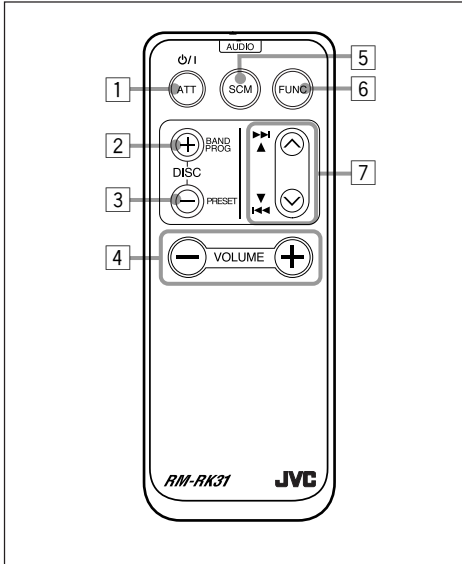

- 1 • Turns on the unit if pressed when the unit is turned off.
 - Turns off the unit if pressed and held until “SEE YOU” appears on the display.
 - Drops the volume level for a moment if pressed briefly.
Press again to resume the volume.
- 2 • Functions as the BAND button while listening to the radio (or the DAB tuner).
Each time you press the button, the band changes.
 - Functions as the DISC + button while listening to the CD changer.
Each time you press the button, the disc number increases, and the selected disc starts playing.
 - Does not function as the PROG button.

- 3 • Functions as the PRESET button while listening to the radio (or the DAB tuner).
Each time you press the button, the preset station number increases, and the selected station is tuned in.
 - Functions as the DISC – button while listening to the CD changer.
Each time you press the button, the disc number decreases, and the selected disc starts playing.
- 4 Functions the same as the control dial on the main unit.
NOTE: This button does not function for the preferred setting mode adjustment.
- 5 Selects the sound mode.
Each time you press SCM (Sound Control Memory), the mode changes.
- 6 Selects the source.
Each time you press FUNC (function), the source changes.
- 7 • Searches stations while listening to the radio.
 - Selects services while listening to the DAB tuner if pressed briefly.
 - Searches ensembles while listening to the DAB tuner if pressed for more than 1 second.
 - Fast-forwards or reverses the track if pressed and held while listening to a CD.
 - Skips to the beginning of the next track or goes back to the beginning of the current (or previous) track if pressed briefly while listening to a CD.

Preparing the remote controller

Before using the remote controller:

- Aim the remote controller directly at the remote sensor on the main unit. Make sure there is no obstacle in between.

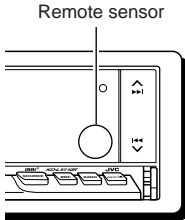

- Do not expose the remote sensor to strong light (direct sunlight or artificial lighting).

Installing the battery

When the controllable range or effectiveness of the remote controller decreases, replace the battery.

1. Remove the battery holder.

- 1) Push out the battery holder in the direction indicated by the arrow using a ball-point pen or a similar tool.
- 2) Remove the battery holder.

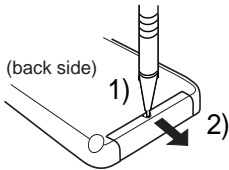

2. Place the battery.

Slide the battery into the holder with the + side facing upwards so that the battery is fixed in the holder.

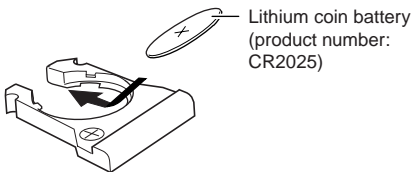

3. Return the battery holder.

Insert again the battery holder pushing it until you hear a clicking sound.

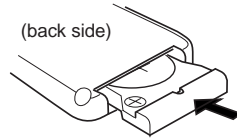

WARNING:

- Store the batteries in a place which children cannot reach.
If a child accidentally swallows the batteries, immediately consult a doctor.
- Do not recharge, short, disassemble or heat the batteries or dispose of in a fire.
Doing any of these things may cause the batteries to give off heat, crack or start a fire.
- Do not leave the batteries with other metallic materials.
Doing this may cause the batteries to give off heat, crack or start a fire.
- When throwing away or saving batteries, wrap in tape and insulate; otherwise, it may cause the batteries to give off heat, crack or start a fire.
- Do not poke the batteries with tweezers or similar tools.
Doing this may cause the batteries to give off heat, crack or start a fire.

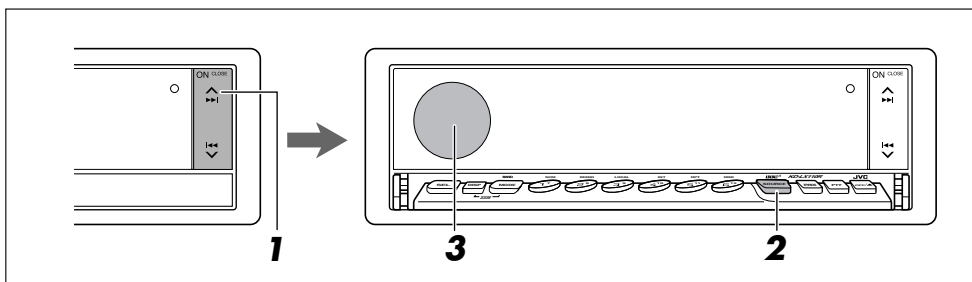

1 Turn on the power.

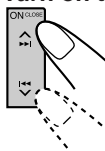

The display illuminates and the control panel and control dial come out.

2 Select the source.



Each time you press the button, the source changes as follows:

- FM → DAB tuner** → CD*
- CD changer or external component**
- AM → (back to the beginning)

* If a CD is not in the loading slot, you cannot select CD as the source to play.

** Without connecting the equipment and setting "EXT INPUT" correctly (see page 25), you cannot select it as the source to play.

To operate the tuner (FM or AM), see pages 8 – 15.

To operate the CD player, see pages 16 – 18.

To operate the CD changer, see pages 29 – 31.

To operate the external component, see page 32.

To operate the DAB tuner, see pages 33 – 36.

Note on display illustrations:

Illustrations will differ from what appears if "CLOCK DISP" is set to "CLOCK OFF."
See page 24.

3 Adjust the volume.

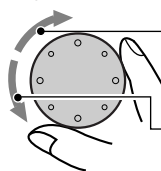

To increase the volume.

To decrease the volume.



Volume level meter

4 Adjust the sound as you want (see page 19).

To drop the volume in a moment

Press SOURCE for more than 1 second while listening to any source. "ATT" starts flashing on the display, and the volume level will drop in a moment. To resume the previous volume level, press the button for more than 1 second again.

To turn off the power

Press and hold OFF/▲ until "SEE YOU" appears on the display.

Note:

When you use this unit for the first time, set the built-in clock correctly, see page 22.

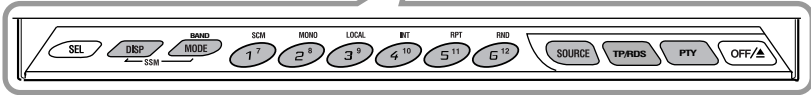
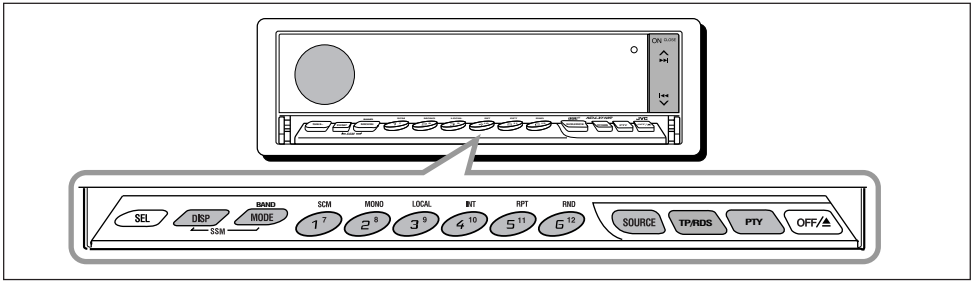

Listening to the radio

You can use either automatic searching or manual searching to tune into a particular station.

Searching a station automatically: Auto search

1 Select the band.

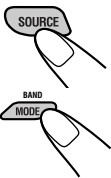

- 1 Press SOURCE to select FM or AM as the source.
- 2 If necessary, press and hold MODE BAND to select the FM band number (FM1, FM2 or FM3).

Each time you press and hold the button, the FM band changes as follows:



Selected band appears.

Note:

This receiver has three FM bands (FM1, FM2, FM3). You can use any one of them to listen to an FM broadcast.

2 Start searching a station.

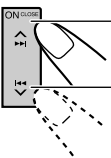

- Press ▲▶▶ to search stations of higher frequencies.
- Press ◀◀▼ to search stations of lower frequencies.

When a station is received, searching stops.

To stop searching before a station is received, press the same button you have pressed for searching.

To tune in FM stations only with strong signals

- 1 Press MODE BAND.
“MODE” appears on the lower part of the display, and the number buttons can work as different function buttons.
- 2 Press LOCAL, while “MODE” is still on the display, so that the LOCAL indicator lights up on the display.
This function works only while searching FM stations, including SSM preset (see page 9). Each time you press the button, the LOCAL indicator lights up and goes off alternately.

Searching a station manually: Manual search

1 Select the band.

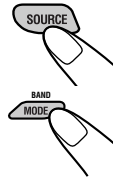

- 1 Press SOURCE to select FM or AM as the source.
- 2 If necessary, press and hold MODE BAND to select the FM band number (FM1, FM2 or FM3).

Each time you press and hold the button, the FM band changes as follows:

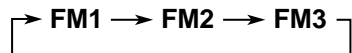

Note:

This receiver has three FM bands (FM1, FM2, FM3). You can use any one of them to listen to an FM broadcast.

- 2** Press and hold \blacktriangle \blacktriangleright \blacktriangleleft or \blacktriangleleft \blacktriangleright \blacktriangledown until “M” (manual) starts flashing on the display.

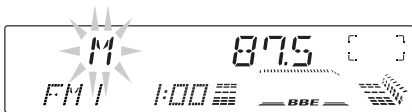

- 3** Tune into a station you want while “M” is flashing.

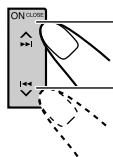

Press \blacktriangle \blacktriangleright \blacktriangleleft to tune into stations of higher frequencies.

Press \blacktriangleleft \blacktriangleright \blacktriangledown to tune into stations of lower frequencies.

- If you release your finger from the button, the manual mode will automatically turn off after 5 seconds.
- If you hold down the button, the frequency keeps changing (in 50 kHz intervals for FM and 9 kHz intervals for AM — MW/LW) until you release the button.

When an FM stereo broadcast is hard to receive:

- 1 Press MODE BAND while listening to an FM stereo broadcast (the ST indicator lights up while receiving an FM stereo broadcast). “MODE” appears on the lower part of the display, and the number buttons can work as different function buttons.
- 2 Press MONO, while “MODE” is still on the display, so that the MO indicator lights up on the display. The sound you hear becomes monaural but the reception will be improved (the ST indicator goes off).

Each time you press the button, the MO indicator lights up and goes off alternately.

Storing stations in memory

You can use one of the following two methods to store broadcasting stations in memory.

- Automatic preset of FM stations: SSM (Strong-station Sequential Memory)
- Manual preset of both FM and AM stations

FM station automatic preset: SSM

You can preset 6 local FM stations in each FM band (FM1, FM2 and FM3).

- 1** Select the FM band (FM1–3) you want to store FM stations into.



- 1 Press SOURCE to select FM as the source.

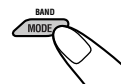

- 2 If necessary, press and hold MODE BAND to select the FM band number (FM1, FM2 or FM3).

Each time you press and hold the button, the FM band changes as follows:



- 2** Press and hold both buttons for more than 2 seconds.

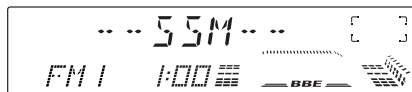
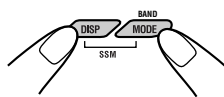

“SSM” appears, then disappears when automatic preset is over.

Local FM stations with the strongest signals are searched and stored automatically in the band number you have selected (FM1, FM2 or FM3). These stations are preset in the number buttons — No.1 (lowest frequency) to No.6 (highest frequency).

When automatic preset is over, the station stored in number button 1 will be automatically tuned in.



Manual preset

You can preset up to 6 stations in each band (FM1, FM2, FM3 and AM) manually.

Ex.: Storing an FM station of 88.3 MHz into the preset number 1 of the FM1 band

1 Select the band (FM1).

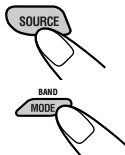

1 Press SOURCE to select FM as the source.

2 Press and hold MODE BAND repeatedly to select the FM1 band.

2 Tune into a station of 88.3 MHz.

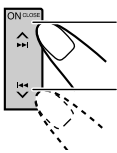

Press \blacktriangle \blacktriangleright to tune into stations of higher frequencies.

Press \blacktriangleleft \blacktriangleright to tune into stations of lower frequencies.



3 Press and hold the number button (in this example, 1) for more than 2 seconds.

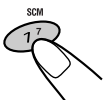

Band number and "MEMO" appear alternately for a while.

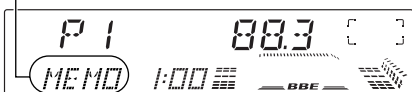

4 Repeat the above procedure to store other stations into other preset numbers.

Notes:

- A previously preset station is erased when a new station is stored in the same preset number.
- Preset stations are erased when the power supply to the memory circuit is interrupted (for example, during battery replacement). If this occurs, preset the stations again.

Tuning into a preset station

You can easily tune into a preset station. Remember that you must store stations first. If you have not stored them yet, see "Storing stations in memory" on pages 9 and 10.

1 Select the band.

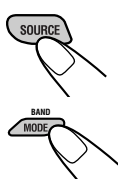

1 Press SOURCE to select FM or AM as the source.

2 If necessary, press and hold MODE BAND to select the FM band number (FM1, FM2 or FM3).

Each time you press and hold the button, the FM band changes as follows:



2 Select the number (1 – 6) for the preset station you want.

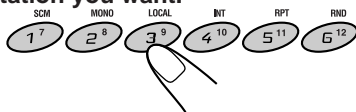

If the sound quality decreases and the stereo effect is lost while listening to an FM station

In some areas, adjacent stations may interfere with each other. If this interference occurs, this unit can automatically reduce this interference noise (the initial setting when shipped from the factory). However, in this case, the sound quality will be degraded and the stereo effect will be also lost.

If you do not want to degrade the sound quality and to lose the stereo effect, rather than to eliminate the interference noise, see "To change the FM tuner selectivity — IF FILTER" on page 25.



What you can do with RDS EON

RDS (Radio Data System) allows FM stations to send an additional signal along with their regular programme signals. For example, the stations send their station names, as well as information about what type of programme they broadcast, such as sports or music, etc.

Another advantage of RDS function is called “EON (Enhanced Other Networks).” The EON indicator lights up while receiving an FM station with the EON data. By using the EON data sent from a station, you can tune into a different station of a different network broadcasting your favourite programme or traffic announcement while listening to another programme or to another source such as CD.

By receiving the RDS data, this unit can do the following:

- Tracing the same programme automatically (Network-Tracking Reception)
- Standby Reception of TA (Traffic Announcement) or your favourite programme
- PTY (Programme Type) search
- Programme search
- And some other functions

Tracing the same programme automatically (Network-Tracking Reception)

When driving in an area where FM reception is not good, the tuner built in this unit automatically tunes into another RDS station, broadcasting the same programme with stronger signals. So, you can continue to listen to the same programme in its finest reception, no matter where you drive. (See the illustration on the next page.)

Two types of the RDS data are used to make Network-Tracking Reception work correctly — PI (Programme Identification) and AF (Alternative Frequency).

Without receiving these data correctly from the RDS station you are listening to, Network-Tracking Reception will not operate.

To use **Network-Tracking Reception**, press and hold TP/RDS (traffic programme/radio data system) for more than 1 second. Each time you press and hold the button, Network-Tracking Reception modes change as follows:

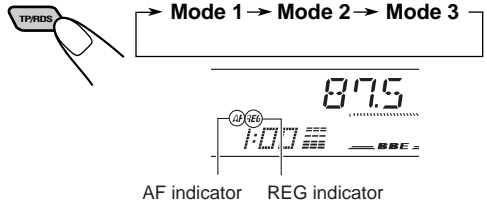

Mode 1

The AF indicator lights up but the REG indicator does not.

Network-Tracking Reception is activated with Regionalization set to “off.”

Switches to another station within the same network when the receiving signals from the current station become weak.

- *In this mode, the programme may differ from the one currently received.*

Mode 2

Both the AF indicator and the REG indicator light up.

Network-Tracking Reception is activated with Regionalization set to “on.”

Switches to another station, within the same network, broadcasting the same programme when the receiving signals from the current station become weak.

Mode 3

Neither the AF indicator nor the REG indicator lights up.

Network-Tracking Reception is deactivated.

Note:

If a DAB tuner is connected and Alternative Reception (for DAB services) is activated, Network-Tracking Reception is also activated automatically. On the other hand, Network-Tracking Reception cannot be deactivated without deactivating Alternative Reception. (See page 36.)



The same programme can be received on different frequencies.

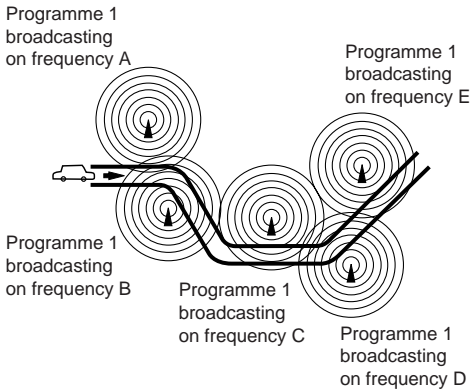

Using Standby Reception

Standby Reception allows the unit to switch temporarily to your favourite programme (PTY: Programme Type) and Traffic Announcement (TA) from the current source (another FM station, CD and other connected components).

- Standby Reception will not work if you are listening to an AM station.

TA Standby Reception

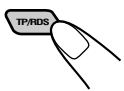

When you press TP/RDS while listening to an FM station, the TP indicator is lit during reception of a TP (Traffic Programme) station and the TA standby mode is engaged.

- When the station being received is not a TP station, the TP indicator flashes. Press **▲▶▶▶** or **▶▶▶▼** to engage the TA standby mode. “SEARCH” appears on the display, and TP station search starts. When a TP station is tuned in, the TP indicator is lit.
- If you are listening to a CD or other connected components and wish to listen to a TP station, press TP/RDS to enter the TA standby mode. (The TP indicator lights up.)

If a traffic programme starts broadcasting while the TA standby mode is active, “TRAFFIC” appears and the playback source changes to the FM band. The volume increases to the preset TA volume level (see page 15) and the traffic programme can be heard.

To deactivate the TA standby mode, press TP/RDS again.

PTY Standby Reception

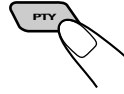

When you press PTY while listening to an FM station, the PTY indicator is lit during reception of a PTY station and the PTY standby mode is engaged. The selected PTY name stored on page 13 flashes for 5 seconds.

- When the station being received is not a PTY station, the PTY indicator flashes. Press **▲▶▶▶** or **▶▶▶▼** to engage the PTY standby mode. “SEARCH” appears on the display, and PTY station search starts. When a PTY station is tuned in, the PTY indicator is lit.
 - If you are listening to a CD or other connected components and wish to listen to a selected PTY broadcast, press PTY to enter the PTY standby mode. (The PTY indicator lights up.)
- If the selected PTY programme starts broadcasting while the PTY standby mode is active, the selected PTY name appears and the playback source changes to the FM band. The selected PTY programme can then be heard.

To deactivate the PTY standby mode, press PTY again.



Selecting your favourite programme for PTY Standby Reception

You can select your favourite programme for PTY Standby Reception to store in memory. When shipped from the factory, "NEWS" is stored as the programme type for PTY Standby Reception.

- 1 Press and hold SEL (select) for more than 2 seconds so that one of the PSM items appears on the display. (PSM: see page 23.)**



- 2 Select "PTY STBY" (standby) if not shown on the display.**

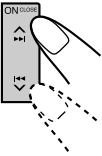

- 3 Select one of twenty-nine PTY codes.**

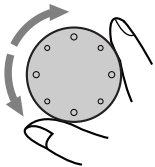

Selected code name appears on the display and is stored into memory.

As you turn the control dial, the PTY codes change as follows:

PTY codes

NEWS ⇄ AFFAIRS ⇄ INFO ⇄
 SPORT ⇄ EDUCATE ⇄ DRAMA ⇄
 CULTURE ⇄ SCIENCE ⇄ VARIED ⇄
 POP M ⇄ ROCK M ⇄ EASY M ⇄
 LIGHT M ⇄ CLASSICS ⇄ OTHER M ⇄
 WEATHER ⇄ FINANCE ⇄ CHILDREN ⇄
 SOCIAL ⇄ RELIGION ⇄ PHONE IN ⇄
 TRAVEL ⇄ LEISURE ⇄ JAZZ ⇄
 COUNTRY ⇄ NATION M ⇄ OLDIES ⇄
 FOLK M ⇄ DOCUMENT ⇄ (back to the beginning)

For details, see page 36.

- 4 Press SEL (select) to finish the setting.**



Searching your favourite programme

You can search one of your 6 favourite programme types stored in memory.

When shipped from the factory, the following 6 programme types have been stored in the number buttons (1 to 6).

To store your favourite programme types, see below.

To search your favourite programme type, see page 14.

1	2	3
POP M	ROCK M	EASY M
4	5	6
CLASSICS	AFFAIRS	VARIED

To store your favourite programme types

- 1 Press and hold SEL (select) for more than 2 seconds so that one of the PSM items appears on the display. (PSM: see page 23.)**

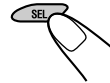

- 2 Select "PTY SEARCH" if not shown on the display.**

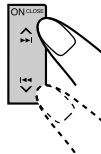

- 3 Select one of twenty-nine PTY codes. (See left column.)**

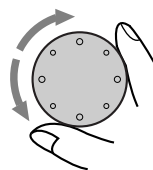

Selected code name appears on the display.

- If the code already stored in memory is selected, it will flash on the display.

CONTINUED ON THE NEXT PAGE



4 Press and hold the number button for more than 2 seconds to store the PTY code selected into the preset number you want.

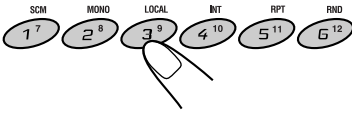

PTY preset number appears, and selected code name and "MEMORY" alternate on the display.

5 Press SEL (select) to finish the setting.



To search your favourite programme type

1 Press and hold PTY (programme type) for more than 1 second while listening to an FM station.

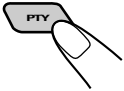

The last selected PTY code and preset number appear.



2 Select one of the PTY codes stored in preset number buttons (1 to 6).

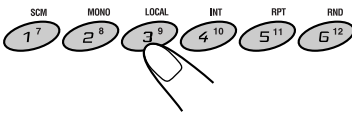

PTY search for your favourite programme starts after 5 seconds.

- If there is a station broadcasting a programme of the same PTY code you selected, that station is tuned in.
- If there is no station broadcasting a programme of the same PTY code you selected, the station will not change.

Note:

In some areas, the PTY search will not work correctly.

Other convenient RDS functions and adjustments

Automatic selection of the station when using the number buttons

Usually when you press the number button, the preset station is tuned in.

However, when the preset station is an RDS station, something different will happen. If the signals from that preset station are not sufficient for good reception, this unit, using the AF data, tunes in another frequency broadcasting the same programme as the original preset station is broadcasting.

In case no other station is tuned in, you can also search all receivable frequencies for the same programme (Programme search).

To activate programme search, follow the procedure below.

- Programme search takes a while.
- See also "Changing the general settings (PSM)" on page 22.

1 Press and hold SEL (select) for more than 2 seconds so that one of the PSM items appears on the display.

2 Press **▲** **▶▶** or **◀◀** **▼** to select "P(Programme)-SEARCH."

3 Turn the control dial to select "SEARCH ON." Now programme search is activated.

4 Press SEL (select) to finish the setting.

To cancel programme search, repeat the same procedure and select "SEARCH OFF" in step 3 by turning the control dial counterclockwise.



Changing the display mode while listening to an FM station

You can change the initial indication on the display to either station name (PS NAME) or to station frequency (FREQUENCY), while listening to an FM RDS station.

- See also “Changing the general settings (PSM)” on page 22.

- 1 Press and hold SEL (select) for more than 2 seconds so that one of the PSM items appears on the display.
- 2 Press \blacktriangle \blacktriangleright or \blacktriangleleft \blacktriangledown to select “TUNER DISP” (tuner display).
- 3 Turn the control dial to set to the desired indication (“PS NAME” or “FREQUENCY”).
- 4 Press SEL (select) to finish the setting.

Note:

By pressing DISP, you can also change the display while listening to an FM RDS station.

Each time you press the button, the following information appears on the display:

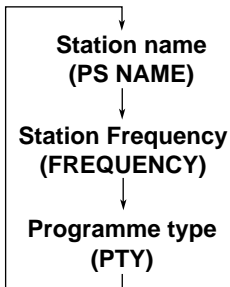

- Then, the display goes back to the original indication in several seconds.

Setting the TA volume level

You can preset the volume level for TA Standby Reception. When a traffic programme is received, the volume level automatically changes to the preset level.

- See also “Changing the general settings (PSM)” on page 22.

- 1 Press and hold SEL (select) for more than 2 seconds so that one of the PSM items appears on the display.
- 2 Press \blacktriangle \blacktriangleright or \blacktriangleleft \blacktriangledown to select “TA VOL” (TA volume).
- 3 Turn the control dial to set to the desired volume. You can set it from “VOL 00” to “VOL 50.”
- 4 Press SEL (select) to finish the setting.

Automatic clock adjustment

When shipped from the factory, the clock built in this unit is set to be readjusted automatically using the CT (Clock Time) data in the RDS signal.

If you do not want to use automatic clock adjustment, follow the procedure below.

- See also “Changing the general settings (PSM)” on page 22.

- 1 Press and hold SEL (select) for more than 2 seconds so that one of the PSM items appears on the display.
- 2 Press \blacktriangle \blacktriangleright or \blacktriangleleft \blacktriangledown to select “AUTO ADJ.”
- 3 Turn the control dial to select “ADJ OFF.”
Now automatic clock adjustment is canceled.
- 4 Press SEL (select) to finish the setting.

To reactivate clock adjustment, repeat the same procedure and select “ADJ ON” in step 3.

Note:

You must stay tuned to the same station for more than 2 minutes after setting “AUTO ADJ” to “ADJ ON.” Otherwise, the clock time will not be adjusted. (This is because the unit takes up to 2 minutes to capture the CT data in the RDS signal.)



CD OPERATIONS

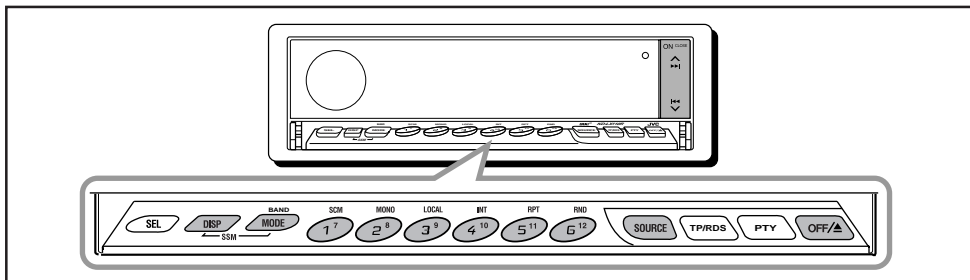

Playing a CD

1 Open the loading slot.

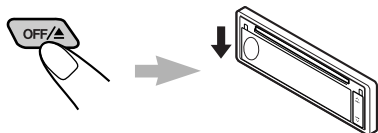

The display panel moves down, and the loading slot appears.

2 Insert a disc into the loading slot.

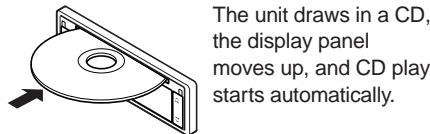

The unit draws in a CD, the display panel moves up, and CD play starts automatically.



The CD indicator lights up.

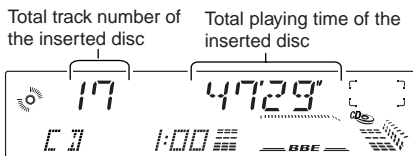

Total track number of the inserted disc

Total playing time of the inserted disc



Current track

Elapsed playing time

Notes:

- When a CD is in the loading slot, selecting "CD" as the source by pressing SOURCE starts CD play.
- When a CD is inserted upside down, the CD automatically ejects. ("CD EJECT" appears on the display.)
- When you play a CD Text, the disc title and performer appear on the display. Then the current track title appears on the display, followed by the track number and elapsed playing time. See also "Playing a CD Text" (page 18) and "To select the scroll mode — SCROLL" (page 24). If a CD Text includes much text information, some may not appear on the display.
- If you change the source, CD play also stops (without ejecting the CD).

To stop play and eject the CD

Press OFF/▲ briefly.

CD play stops, the display panel moves down, then the CD automatically ejects from the loading slot.

To move up the display panel, press ▲▶▶ or ◀◀▼. If no button is pressed, the display panel will move up in about 5 minutes.

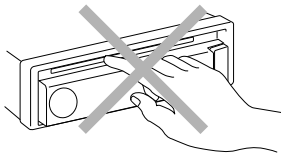

CAUTION: NEVER insert your finger between the display panel and the unit, as it may get caught in the unit.

Note:

If the ejected disc is not removed for about 15 seconds, the disc is automatically inserted again into the loading slot to protect it from dust. (CD play will not start this time.)



Locating a track or a particular portion on a CD

To fast-forward or reverse the track

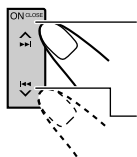

Press and hold **▲▶▶▶**, while playing a CD, to fast-forward the track.

Press and hold **◀◀◀▼**, while playing a CD, to reverse the track.

To go to the next tracks or the previous tracks

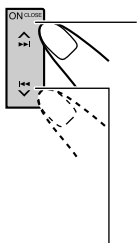

Press **▲▶▶▶** briefly, while playing a CD, to go ahead to the beginning of the next track. Each time you press the button consecutively, the beginning of the next tracks is located and played back.

Press **◀◀◀▼** briefly, while playing a CD, to go back to the beginning of the current track. Each time you press the button consecutively, the beginning of the previous tracks is located and played back.

To go to a particular track directly

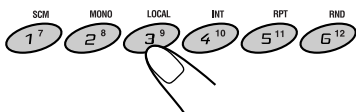

Press the number button corresponding to the track number to start its playback.

- To select a track number from 1 – 6:
Press 1 (7) – 6 (12) briefly.
- To select a track number from 7 – 12:
Press and hold 1 (7) – 6 (12) for more than 1 second.

Selecting CD playback modes

To play back tracks at random (Random Play)

You can play back all tracks on the CD at random.

- Press MODE BAND while playing a CD. “MODE” appears on the lower part of the display, and the number buttons can work as different function buttons.
- Press RND (random), while “MODE” is still on the display, so that the RND indicator lights up on the display.
Each time you press the button, CD random play mode turns on and off alternately.

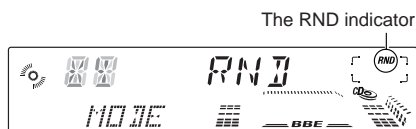

When the random mode is turned on, the RND indicator lights up on the display and a track randomly selected starts playing.

To play back tracks repeatedly (Repeat Play)

You can play back the current track repeatedly.

- Press MODE BAND while playing a CD. “MODE” appears on the lower part of the display, and the number buttons can work as different function buttons.
- Press RPT (repeat), while “MODE” is still on the display, so that the RPT indicator lights up on the display.
Each time you press the button, CD repeat play mode turns on and off alternately.

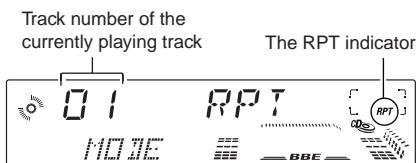

When the repeat mode is turned on, the RPT indicator lights up on the display.



To play back only intros (Intro Scan)

You can play back the first 15 seconds of each track sequentially.

- 1 Press MODE BAND while playing a CD.

“MODE” appears on the lower part of the display, and the number buttons can work as different function buttons.

- 2 Press INT (intro), while “MODE” is still on the display.

Each time you press the button, CD intro scan mode turns on and off alternately.

Track number of the currently playing track

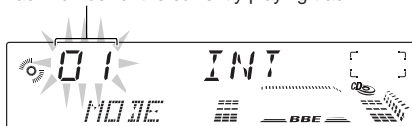

When the intro scan mode is turned on, “INT” appears on the display for 5 seconds and the track number flashes.

Prohibiting CD ejection

You can prohibit CD ejection and can lock a CD in the loading slot.

While pressing SOURCE, press and hold OFF/▲ for more than 2 seconds.

“NO EJECT” flashes on the display for about 5 seconds, and the CD is locked and cannot be ejected.



Note:

If you press OFF/▲ while CD ejection is prohibited, the control panel moves down, but the CD cannot be ejected. (“NO EJECT” appears on the display.)

To move up the display panel, press ▲▶▶ or ◀◀▼.

To cancel the prohibition and unlock the CD, press and hold OFF/▲ for more than 2 seconds again, while pressing SOURCE.

“EJECT OK” flashes on the display for about 5 seconds, and the CD is unlocked.

Playing a CD Text

In a CD Text, some information about the disc (its disc title, performer and track title) is recorded. You can show these disc information on the display.

Select text display mode while playing a CD Text.

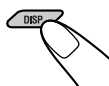

Each time you press the button, the display changes as follows:

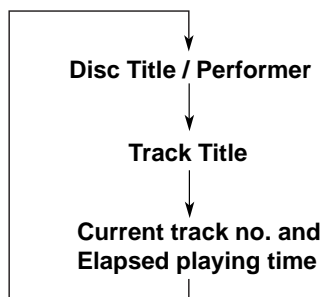

Notes:

- The display shows up to 10 characters at one time and scrolls if there are more than 10 characters. See also “To select the scroll mode — SCROLL” on page 24.
- When you press DISP while playing a conventional CD, “NO NAME” appears for the disc title/performer and the track title.



Adjusting the sound

You can adjust the sound characteristics to your preference.

1 Select the item you want to adjust.



Each time you press the button, the adjustable items change as follows:

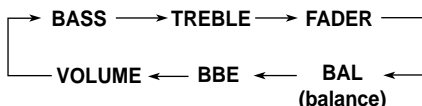

2 Adjust the level.

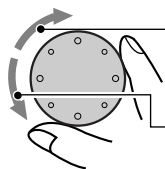

To increase the level.

To decrease the level.



Equalization pattern changes as you adjust the bass or treble.

Note:

Normally the control dial works for volume adjustment. So you do not have to select "VOLUME" to adjust the volume level.

Indication	To do:	Range
BASS	Adjust the bass.	-06 (min.) +06 (max.)
TREBLE	Adjust the treble.	-06 (min.) +06 (max.)
FADER*	Adjust the front and rear speaker balance.	R06 (Rear only) F06 (Front only)
BAL (balance)	Adjust the left and right speaker balance.	L06 (Left only) R06 (Right only)
BBE	See "What is BBE"?" on the next page.	OFF, 1, 2, 3
VOLUME	Adjust the volume.	00 (min.) 50 (max.)

* If you are using a two-speaker system, set the fader level to "00."



What is BBE^{II}?

The BBE^{II}* function restores the brilliance and clarity of the original live sound in recording, broadcasts, etc.

When a speaker reproduces sound, it introduces frequency-dependent phase shifting, causing high-frequency sounds to take longer to reach the ear than low frequency sounds. The BBE^{II} function adjusts the phase relationship between the low, mid and high frequencies by adding a progressively longer delay time to the low and mid frequencies, so that all frequencies reach the listener's ears at the proper time.

In addition, the BBE^{II} function boosts low and high frequencies, which loudspeakers tend to be less efficient in reproducing, through dynamic, program-driven augmentation. When combined with the phase compensation feature, the resulting sound has a clearer, more finely detailed "live" presence.

As you turn the control dial, the BBE^{II} function changes as follows:

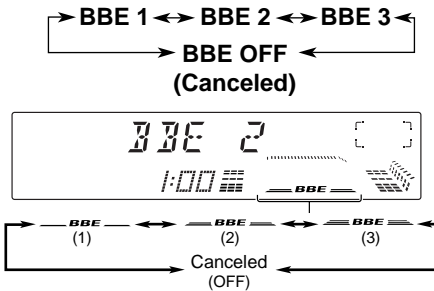

As the number gets higher, the BBE^{II} function becomes stronger.

When shipped from the factory, the BBE^{II} function is set to "BBE 2."

To cancel the BBE^{II} function, select "BBE OFF."

* Under license from BBE Sound, Inc.

BBE^{II} is a trademark of BBE Sound, Inc.

Using the sound control memory

You can select and store a preset sound adjustment suitable for each playback source. (**Advanced SCM**)

Selecting and storing the sound modes

Once you select a sound mode, it is stored in memory. It will be recalled every time you select the same source and will be shown on the display.

A sound mode can be stored for each of the following sources — FM1, FM2, FM3, AM, CD and external components.

- If you do not want to store the sound mode separately for each playback source, but want to use the same sound mode for all the sources, see "To cancel Advanced SCM – SCM LINK" on page 24.

1 Press MODE BAND.

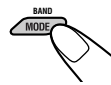

The number buttons can work as different function buttons.



2 Select the sound mode you want.

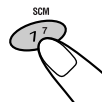

Each time you press the button, the sound mode changes as follows:

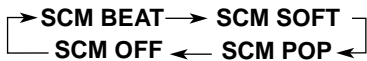

- When "SCM LINK" is set to "LINK ON," the selected sound mode can be stored in memory for the current source and the effect applies only to the current source. Each time you change the playback source, the SCM indicator flashes on the display.
- When "SCM LINK" is set to "LINK OFF," the selected sound mode effect applies to any source.



Indication	For:	Preset values		
		Bass	Treble	BBE ^{II}
SCM BEAT	Rock or disco music	+02	00	2
SCM SOFT	Quiet background music	+01	-03	OFF
SCM POP	Light music	+04	+01	OFF
SCM OFF	(Flat sound)	00	00	2

Recalling the sound modes

When “SCM LINK” is set to “LINK ON,” select the source.

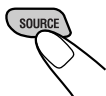

The sound mode stored in memory for the selected source is recalled.



Notes:

- You can adjust each sound mode to your preference, and store it in memory.
If you want to adjust and store your original sound mode, see “Storing your own sound adjustments” on the right column.
- To adjust the bass and treble reinforcement levels or the BBE^{II} function temporarily, see pages 19 and 20. (Your adjustments will be canceled if another source is selected.)

Storing your own sound adjustments

You can adjust the sound modes (SCM BEAT, SCM SOFT, SCM POP) to your preference and store your own adjustments in memory.

- There is a time limit in doing the following procedure. If the setting is canceled before you finish, start from step 1 again.

1 Press MODE BAND.

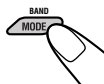

The number buttons can work as different function buttons.

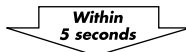

2 Select the sound mode you want.

For details, see page 20.

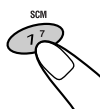

3 1 Select the item you want to adjust (BASS, TREBLE or BBE^{II}).

2 Adjust the selected item.

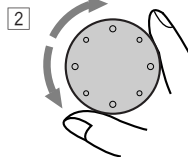
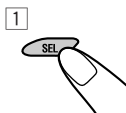

Repeat step 3 to adjust the other items.

4 Press MODE BAND.

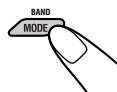

5 Press and hold SCM until the sound mode you have selected flashes on the display.

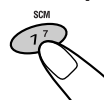

Your adjustment made for the selected sound mode is stored in memory.

6 Repeat the same procedure to adjust other sound modes.

To reset to the factory settings

Repeat the same procedure and reassign the preset values listed in the table on the left column.

Setting the clock

- 1 Press and hold SEL (select) for more than 2 seconds so that one of the PSM items appears on the display. (See page 23.)



- 2 Set the hour.

- 1 Select "CLOCK HOUR" if not shown on the display.
- 2 Adjust the hour.

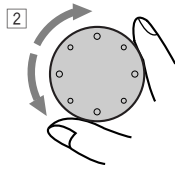
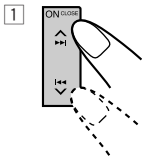

- 3 Set the minute.

- 1 Select "CLOCK MIN."
- 2 Adjust the minute.

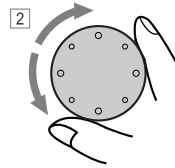
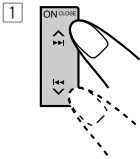

- 4 Set the clock system.

- 1 Select "24H/12H."
- 2 Adjust "24HOUR" or "12HOUR."

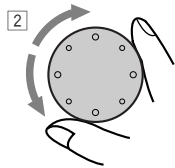
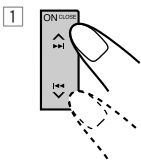

- 5 Press SEL (select) to finish the setting.



Changing the general settings (PSM)

You can change the items listed on the next page by using the PSM (Preferred Setting Mode) control.

Basic Procedure

- 1 Press and hold SEL (select) for more than 2 seconds so that one of the PSM items appears on the display. (See page 23.)



- 2 Select a PSM item you want to adjust. (See page 23.)

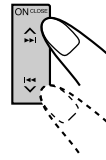

- 3 Adjust the PSM item selected above.

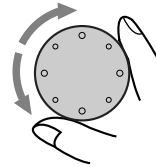

- 4 Repeat steps 2 and 3 to adjust the other PSM items if necessary.

- 5 Press SEL (select) to finish the setting.

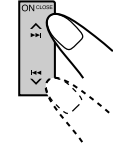
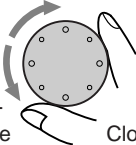

Preferred Setting Mode (PSM) items

		1  Hold.		2  Select.		3  Set. Counter-clockwise Clockwise		Factory-preset settings	See page
CLOCK HOUR	Hour adjustment	Back	Advance	0:00	22				
CLOCK MIN	Minute adjustment	Back	Advance						
SCM LINK	Sound control memory linkage	LINK OFF	LINK ON	LINK ON	20, 24				
24H/12H	24/12-hour time display	12HOUR	24HOUR	24HOUR	22				
AUTO ADJ	Automatic clock setting	ADJ OFF	ADJ ON	ADJ ON	15				
CLOCK DISP	Clock display	CLOCK OFF	CLOCK ON	CLOCK ON	24				
TUNER DISP	Tuner display	FREQUENCY	PS NAME	PS NAME	15				
PTY STBY	PTY standby	29 programme types (See pages 13 and 37.)		NEWS	13				
PTY SEARCH	PTY search			NEWS	13				
TA VOL	Traffic announcement volume	VOL 00 – VOL 50		VOL 20	15				
P-SEARCH	Programme search	SEARCH OFF	SEARCH ON	SEARCH OFF	14				
DAB AF*	Alternative frequency search	AF OFF	AF ON	AF ON	36				
LEVEL	Level display	4 types (See page 24.)		NORMAL	24				
DIMMER	Dimmer mode	AUTO	↔ OFF	AUTO	24				
		↕ ON	↕						
TELEPHONE	Telephone muting	MUTING 1	↔ MUTING 2	MUTING OFF	24				
		↕ MUTING OFF	↕						
BEEP SW	Key-touch tone	BEEP OFF	BEEP ON	BEEP ON	24				
SCROLL	Scroll mode	ONCE	↔ AUTO	ONCE	24				
		↕ OFF	↕						
EXT INPUT**	External component	CHANGER	LINE INPUT	CHANGER	25				
FLAT PANEL	Flat panel	FLAT OFF	FLAT ON	FLAT OFF	25				
IF FILTER	Intermediate frequency filter	WIDE	AUTO	AUTO	25				
DEMO MODE	Demo mode	DEMO OFF	DEMO ON	DEMO ON	25				

4 Press SEL (select) to finish the setting.

* Displayed only when the DAB tuner is connected.

** Displayed only when one of the following sources is selected — FM, AM and CD.

To cancel Advanced SCM — SCM LINK

You can cancel the Advanced SCM (Sound Control Memory), and unlink the sound modes and the playback sources.

When shipped from the factory, a different sound mode can be stored in memory for each source so that you can change the sound modes simply by changing the sources.

- LINK ON: Advanced SCM (different sound modes for different sources)
- LINK OFF: Conventional SCM (one sound mode for all sources)

To set the clock display — CLOCK DISP

You can set the clock to be shown on the lower part of the display when the unit is turned on. When shipped from the factory, the clock is set to be shown on the display.

- CLOCK ON: Clock display is turned on.
- CLOCK OFF: Clock display is turned off. When "CLOCK OFF" is selected, the current sound mode setting (see page 20) is shown on the upper part of the display*.

**If an external source is selected, the current sound mode setting is shown on the lower part of the display.*

To select the level meter — LEVEL

You can select the level meter display according to your preference. When shipped from the factory, "NORMAL" is selected.

- NORMAL: Normal audio level meter (illuminates from bottom to top)
- MIRROR: Volume level meter illuminates as if it were reflected on a mirror.
- LEVEL OFF: Level meter stays lit and does not change its illumination.
- ALL OFF: Level meter turns off.

To select the dimmer mode — DIMMER

When you turn on the car headlights, the display automatically dims (Auto Dimmer).

When shipped from the factory, Auto Dimmer is activated.

- AUTO: Activates Auto Dimmer.
- OFF: Cancels Auto Dimmer.
- ON: Always dims the display.

Note on Auto Dimmer:

Auto Dimmer equipped with this unit may not work correctly on some vehicles, particularly on those having a control dial for dimming. In this case, set the dimmer mode to "ON" or "OFF."

To select the telephone muting — TELEPHONE

This mode is used when a cellular phone system is connected. Depending on the phone system used, select either "MUTING 1" or "MUTING 2," whichever mutes the sounds from this unit. When shipped from the factory, this mode is deactivated.

- MUTING 1: Select this if this setting can mute the sounds.
- MUTING 2: Select this if this setting can mute the sounds.
- MUTING OFF: Cancels the telephone muting.

To turn on/off the key-touch tone — BEEP SW

You can deactivate the key-touch tone if you do not want it to beep each time you press a button. When shipped from the factory, the key-touch tone is activated.

- BEEP ON: Activates the key-touch tone.
- BEEP OFF: Deactivates the key-touch tone.

To select the scroll mode — SCROLL

You can select the scroll mode for the disc information if it consists of more than 10 characters. When shipped from the factory, Auto Scroll mode is set to "ONCE."

- ONCE: Scrolls only once.
- AUTO: Repeats the scroll (in 5-second intervals).
- OFF: Cancels Auto Scroll.

Note:

Even if the scroll mode is set to "OFF," you can scroll the display by pressing DISP for more than 1 second.

To select the external component to use — EXT INPUT



You can connect the external component to the CD changer jack on the rear using the Line Input Adaptor KS-U57 (not supplied).

To use the external component as the playback source through this unit, you need to select which component — CD changer or external component — to use. When shipped from the factory, “CHANGER” is selected as the external component.



- **CHANGER:** To use the CD changer
- **LINE INPUT:** To use the external component other than the CD changer

To make the front panel look flat (hiding the control panel) — FLAT PANEL

When operating the receiver using the remote control, you can hide the control panel to make the front panel look flat. When shipped from the factory, “FLAT OFF” is selected.

- **FLAT ON:** The control panel will not come out when you turn on the unit.
To use the control panel, press    so that the control panel comes out. If no operation is done for about 10 seconds, it automatically goes back into the receiver.
- **FLAT OFF:** You can use the control panel normally.

Note:

When “FLAT ON” is selected, you can eject a CD by holding   .

To change the FM tuner selectivity — IF FILTER

In some areas, adjacent stations may interfere with each other. If this interference occurs, noise may be heard. This unit has been preset to automatically reduce this interference noise (“AUTO”) when shipped from the factory.

- **AUTO:** When this type of interference occurs, this unit automatically increases the tuner selectivity so that interference noise will be reduced. (But the stereo effect will also be lost)
- **WIDE:** Subject to the interference from adjacent stations, but sound quality will not be degraded and the stereo effect will not be lost.

To turn the demo mode on or off — DEMO MODE

You can turn the demo mode on or off. When shipped from the factory, “DEMO ON” is selected.

- **DEMO ON:** Turns the demo mode on. The demonstration will start automatically if no sound comes in for 3 minutes.
- **DEMO OFF:** Turns the demo mode off.

Note:

If the unit has been reset (and the power is on), demonstration will start if no sound comes in for about 10 seconds.

Assigning names to CDs

You can assign names to CDs. After assigning a name, it will appear on the display when you select the CD player or CD changer.

Maximum number of the characters:

Up to 32 characters (up to 40 discs)

Note:

You cannot assign a name to a CD Text.

- 1 Select a source you want to assign a name to.



- 2 Press and hold SEL (select) for more than 2 seconds while pressing DISP.

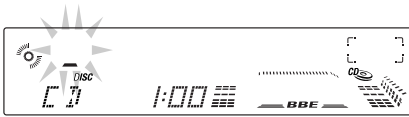
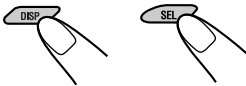

- 3 Select a character.

About the available characters, see the right column.

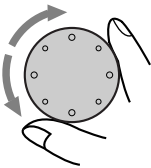

- 4 Move the cursor to the next (or previous) character position.

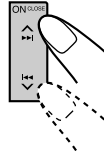

- 5 Repeat steps 3 and 4 until you finish inputting the name.

- 6 Press the button while the last selected character is flashing.

The input name is stored in memory.

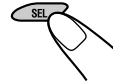

To erase the input characters

Insert spaces using the same procedure described above.

Available characters

A	B	C	D	E	F	G	H	I	J
K	L	M	N	O	P	Q	R	S	T
U	V	W	X	Y	Z	0	1	2	3
4	5	6	7	8	9	-	/	<	>
space									

Notes:

- When you try to assign a name to the 41st disc, "NAME FULL" appears on the display. (In this case, delete unwanted names before assignment.)
- When the CD changer is connected, you can assign names to CDs in the CD changer. These names can also be shown on the display if you insert the CDs in this unit.

Using the security lock

You can prohibit the unauthorized use of this unit by the others.

To use the security lock, you need to set the password first. Once you set the password, the unit will ask you to enter the password when you turn on the unit for the first time after re-installation (or after recovering the car battery exhaustion).

CAUTION: Be careful not to forget the password you have entered; otherwise, you cannot use this unit. Keep the password in your mind and more importantly on paper or some other materials. You can write down your password in the spaces provided on the cover page.

Registering the password

You have to use 4 characters for your password. You can use the following characters: Capital letters (A – Z) and numerals (0 – 9).

- 1 Press and hold both buttons for more than 2 seconds.**

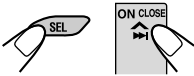

The unit enters password entry mode.

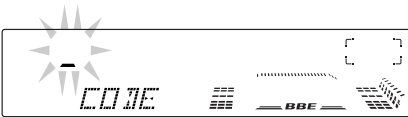

- 2 Select a character.**

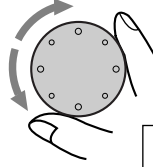

As you turn the control dial, character changes as follows:

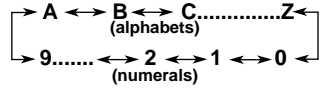

- 3 Move the character entry position to the next.**

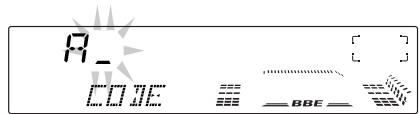
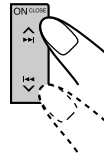

- 4 Repeat steps 2 and 3 until you enter all 4 characters.**

- 5 Press SEL (select) to finish the setting.**

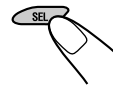

The password flashes on the display for a while, then the unit returns to the normal operation mode.

How to Use the Provided CODE Sticker

Attach the provided CODE sticker in a conspicuous position on your car to notify would-be unauthorized users that the security lock function is provided for this unit and, therefore, will foil their efforts.

When Security Lock works?

Once you register the password, “* * * *” appears on the display, and the unit will ask you to enter the password in the following cases:

- When you turn on the unit for the first time after re-installing the unit.
- When you turn on the unit for the first time after replacing the car battery.

To use this unit, you must enter the correct password by following the procedure below.

- 1** Turn the control dial to enter a character.
- 2** Press **▲ ►►** or **◄◄ ▼** to move the character entry position.
- 3** Repeat steps 1 and 2 to enter the entire password (4 letters) correctly, then press SEL (select).
 - If you enter the correct password, the security lock is canceled and you can use the unit normally.
 - In the following cases, the security lock is not canceled (“NOT ACCEPT” appears on the display) then the unit turns off. (The unit will never turn on unless you press the reset button on the front panel. See page 2.)
 - If you enter an incorrect password then press SEL (select).
 - If you cannot finish entering the correct password within 30 seconds.

If you enter an incorrect character while entering the password

Press **◄◄ ▼** to move back the character entry position over the incorrect character, then turn the control dial to select the correct character.

To change the password

If you want to change the password after you have registered it, follow the procedure below.

- 1** Press SEL (select) and **▲ ►►** at the same time for more than 2 seconds. “* * * *” appears on the display.
- 2** Enter the current password correctly, then press SEL (select).
The unit enters password entry mode.
- 3** Enter a new password as you want, then press SEL (select).
The password flashes on the display for a while, then the unit returns to the normal operation mode.
 - See page 27 for details on how to enter the password.

CD CHANGER OPERATIONS

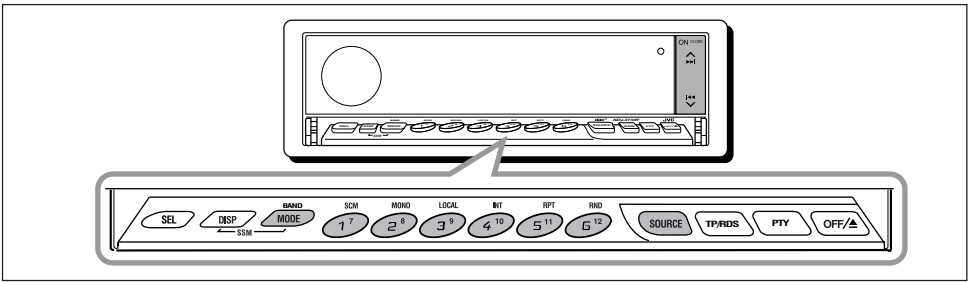

We recommend that you use one of the CH-X series with your unit.

If you have another CD automatic changer, consult your JVC IN-CAR ENTERTAINMENT dealer for connections.

- For example, if your CD automatic changer is one of the KD-MK series, you need a cord (KS-U15K) for connecting it to this unit.

Before operating your CD automatic changer:

- Refer also to the Instructions supplied with your CD changer.
- If no discs are in the magazine of the CD changer or the discs are inserted upside down, "NO DISC" will appear on the display. If this happens, remove the magazine and set the discs correctly.
- If "RESET 1" - "RESET 8" appears on the display, something is wrong with the connection between this unit and the CD changer. If this happens, check the connection, connect the connecting cord(s) firmly if necessary, then press the reset button of the CD changer.

Playing CDs

Select the CD automatic changer.



Each time you press the button, the source changes as described on page 7.

Playback starts from the first track of the first disc.

All tracks of all discs are played back.

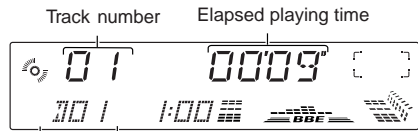

Disc number appears.

To fast-forward or reverse the track

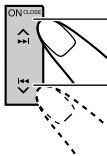

Press and hold **FF**, while playing a CD, to fast-forward the track.

Press and hold **REW**, while playing a CD, to reverse the track.

To go to the next track or the previous tracks

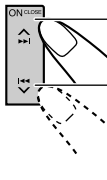

Press **NEXT** briefly, while playing a CD, to go ahead to the beginning of the next track. Each time you press the button consecutively, the beginning of the next track is located and played back.

Press **PREV** briefly, while playing a CD, to go back to the beginning of the current track. Each time you press the button consecutively, the beginning of the previous tracks is located and played back.



To go to a particular disc directly

Press the number button corresponding to the disc number to start its playback (while the CD changer is playing).

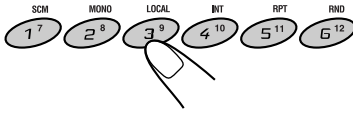

- To select a disc number from 1 – 6: Press 1 (7) – 6 (12) briefly.
- To select a disc number from 7 – 12: Press and hold 1 (7) – 6 (12) for more than 1 second.

Track number Elapsed playing time



Disc number

Ex.: When disc number 3 is selected

To show the CD Text information

This is possible only when connecting a JVC CD automatic changer equipped with CD Text reading capability.

See “Playing a CD Text” on page 18.

Selecting CD playback modes

- There is a time limit in doing the following procedure. If the setting is cancelled before you finish, start from step 1 again.

To play back tracks at random (Random Play)

- 1 Press MODE BAND while playing a CD. “MODE” appears on the display.

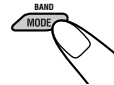

- 2 Press RND (random), while “MODE” is still on the display, so that the RND indicator lights up on the display. Each time you press the button, CD random play mode changes as follows:

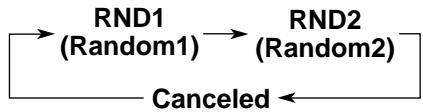
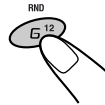

Mode	RND Indicator	Plays at random
RND1	Lights	All tracks of the current disc, then the tracks of the next disc, and so on.
RND2	Flashes	All tracks of all discs inserted in the magazine.

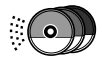

To play back tracks repeatedly (Repeat Play)

1 Press MODE BAND while playing a CD.
"MODE" appears on the display.

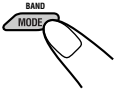

**Within
5 seconds**

2 Press RPT (repeat), while "MODE" is still on the display, so that the RPT indicator lights up on the display.

Each time you press the button, CD repeat play mode changes as follows:

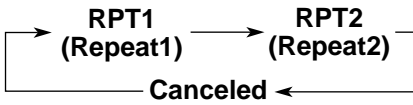
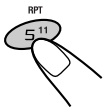

Mode	RPT Indicator	Plays repeatedly
RPT1	Lights	The current track (or specified track).
RPT2	Flashes	All tracks of the current disc (or specified disc).

To play back only intros (Intro Scan)

1 Press MODE BAND while playing a CD.
"MODE" appears on the display.

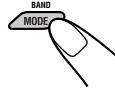

**Within
5 seconds**

2 Press INT (intro), while "MODE" is still on the display.

Each time you press the button, CD intro scan mode changes as follows:

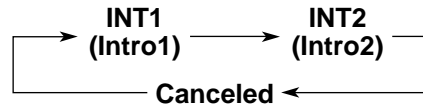
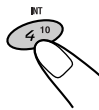

Mode	Indication	Plays the beginnings (15 seconds)
INT1	Track number flashes	Of all tracks on all inserted discs.
INT2	Disc number flashes (when it is shown on the display)	Of the first track on each inserted disc.



EXTERNAL COMPONENT OPERATIONS

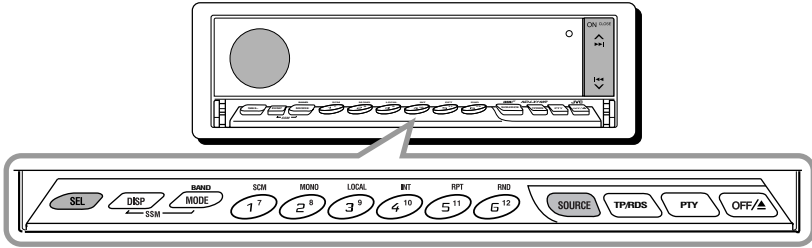

Playing an external component

You can connect the external component to the CD changer jack on the rear using the Line Input Adaptor KS-U57 (not supplied).

Preparations:

- For connecting the Line Input Adaptor KS-U57 and the external component, refer to the Installation/Connection Manual (separate volume).
- Before operating the external component using the following procedure, select the external input correctly. (See “To select the external component to use — EXT INPUT” on page 25.)

1 Select the external component.

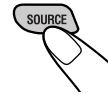

Each time you press the button, the source changes as described on page 7.



2 Operate the external component.

3 Adjust the volume.

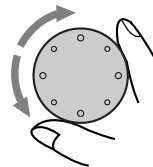

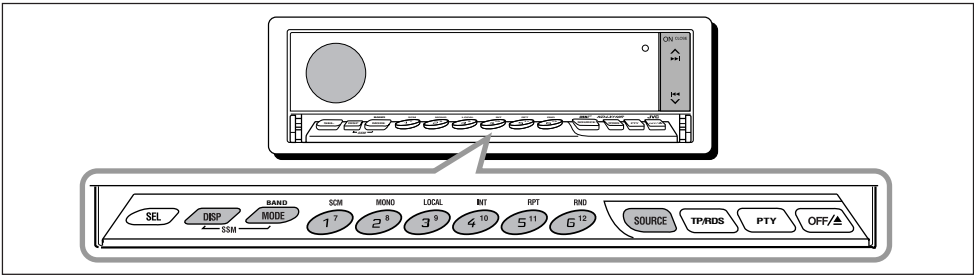

We recommend that you use DAB (Digital Audio Broadcasting) tuner KT-DB1500 with your unit. If you have another DAB tuner, consult your JVC IN-CAR ENTERTAINMENT dealer.

- Refer also to the Instructions supplied with your DAB tuner.

What is DAB system?

DAB is one of the digital radio broadcasting systems available today. It can deliver CD quality sound without any annoying interference and signal distortion. Furthermore, it can carry text, pictures and data.

In contrast to FM broadcast, where each programme is transmitted on its own frequency, DAB combines several programmes (called "services") to form one "ensemble."

With the DAB tuner connected with this unit, you can enjoy these DAB services.

Tuning into an ensemble and one of the services

A typical ensemble has 6 or more programmes (services) broadcast at the same time. After tuning into an ensemble, you can select a service you want to listen to.

1 Select the DAB tuner (DAB1–3).



2 Select the DAB band (DAB1, DAB2, or DAB3).

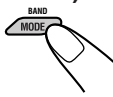

Each time you press and hold the button, the DAB band changes as follows:



Note:

This receiver has three DAB bands (DAB1, DAB2, DAB3). You can use any of them to tune into an ensemble.

3 Start searching an ensemble.

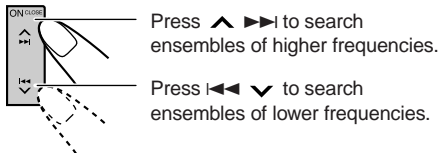

When an ensemble is received, searching stops.

To stop searching before an ensemble is received, press the same button you have pressed for searching.

4 Select a service you want to listen to.

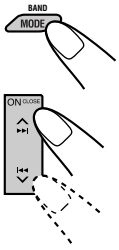

- 1 Press MODE BAND. "MODE" appears on the display.
- 2 Press \blacktriangle \blacktriangleright or \blacktriangleleft \blacktriangledown to select a service you want, while "MODE" is still on the display.

To change the display information while tuning into an ensemble

Normally service name is shown on the display. If you want to check the ensemble name or its frequency, press DISP (display). Each time you press the button, the following information appears for a while on the display.

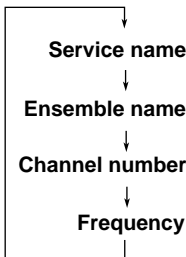

To tune in a particular ensemble without searching:

- 1 Press SOURCE to select DAB tuner as the source.
- 2 Press MODE BAND repeatedly to select the DAB band (DAB1, DAB2, or DAB3).
- 3 Press and hold \blacktriangle \blacktriangleright or \blacktriangleleft \blacktriangledown for more than 1 second.
- 4 Press \blacktriangle \blacktriangleright or \blacktriangleleft \blacktriangledown repeatedly until the ensemble you want is reached.
 - If you hold down the button, the ensemble keeps changing until you release the button.

Storing DAB services in memory

You can preset up to 6 DAB services in each DAB band (DAB1, DAB2 and DAB3) manually.

1 Select the DAB tuner (DAB1–3).

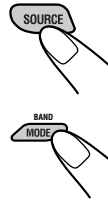

- 1 Press SOURCE to select DAB tuner as the source.
- 2 If necessary, press and hold MODE BAND repeatedly to select the DAB band number (DAB1, DAB2 or DAB3).

Each time you press and hold the button, the DAB band changes as follows:



2 Tune into an ensemble you want.

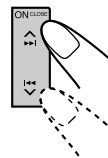

3 Select a service of the ensemble you want.

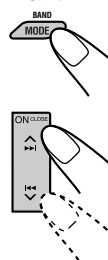

- 1 Press MODE BAND. "MODE" appears on the display.
- 2 Press \blacktriangle \blacktriangleright or \blacktriangleleft \blacktriangledown to select a service you want, while "MODE" is still on the display.

- 4** Press and hold the number button (in this example, 1) you want to store the selected service into for more than 2 seconds.

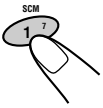

Band number and "MEMO" appear alternately for a while.

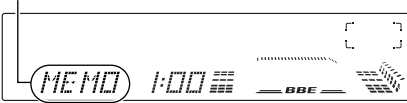

- 5** Repeat the above procedure to store other DAB services into other preset numbers.

Notes:

- A previously preset DAB service is erased when a new DAB service is stored in the same preset number.
- Preset DAB services are erased when the power supply to the memory circuit is interrupted (for example, during battery replacement). If this occurs, preset the DAB services again.

Tuning into a preset DAB service

You can easily tune into a preset DAB service. Remember that you must store services first. If you have not stored them yet, see pages 34 and 35.

- 1** Select the DAB tuner (DAB1–3).



- 1 Press SOURCE to select DAB tuner as the source.

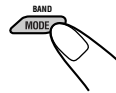

- 2 If necessary, press and hold MODE BAND repeatedly to select the DAB band number (DAB1, DAB2 or DAB3).

Each time you press and hold the button, the DAB band changes as follows:



- 2** Select the number (1 – 6) for the preset DAB service you want.

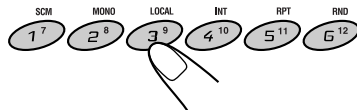

What you can do more with DAB

Tracing the same program automatically (Alternative Reception)

You can keep listening to the same program.

- **While receiving a DAB service:**

When driving in an area where a service cannot be received, this unit automatically tunes in another ensemble or FM RDS station, broadcasting the same program.

- **While receiving an FM RDS station:**

When driving in an area where a DAB service is broadcasting the same program as the FM RDS station is broadcasting, this unit automatically tunes into the DAB service.

Note:

When reception switches between DAB and FM, the listening volume level may increase or decrease inconveniently. This change in the volume level results from unequal audio injection levels at broadcaster site, but not from the malfunction of this unit.

To use Alternative Reception

When shipped from the factory, Alternative Reception is activated.

- 1 Press and hold SEL (select) for more than 2 seconds so that one of the PSM items appears on the display.
- 2 Press **▲ ▶▶|** or **|◀◀ ▼** to select "DAB AF" (alternative frequency).
- 3 Turn the control dial to select the desired mode.
 - AF ON: Traces the program among DAB services and FM RDS stations — Alternative Reception. The AF indicator lights up on the display (see page 11).
 - AF OFF: Deactivates Alternative Reception

Note:

When Alternative Reception (for DAB services) is activated, Network-Tracking Reception (for RDS stations: see page 11) is also activated automatically. On the other hand, Network-Tracking Reception cannot be deactivated without deactivating Alternative Reception.

- 4 Press SEL (select) to finish the setting.

ADDITIONAL INFORMATION

PTY codes

NEWS:	News	SOCIAL:	Programmes on social activities
AFFAIRS:	Topical programmes expanding on current news or affairs	RELIGION:	Programmes dealing with any aspect of belief or faith, or the nature of existence or ethics
INFO:	Programmes which impart advice on a wide variety of topics	PHONE IN:	Programmes where people can express their views either by phone or in a public forum
SPORT:	Sport events	TRAVEL:	Programmes about travel destinations, package tours, and travel ideas and opportunities
EDUCATE:	Educational programmes	LEISURE:	Programmes concerned with recreational activities such as gardening, cooking, fishing, etc.
DRAMA:	Radio plays	JAZZ:	Jazz music
CULTURE:	Programmes on national or regional culture	COUNTRY:	Country music
SCIENCE:	Programmes on natural science and technology	NATION M:	Current popular music from another nation or region, in that country's language
VARIED:	Other programmes like comedies or ceremonies	OLDIES:	Classic pop music
POP M:	Pop music	FOLK M:	Folk music
ROCK M:	Rock music	DOCUMENT:	Programmes dealing with factual matters, presented in an investigative style
EASY M:	Easy-listening music		
LIGHT M:	Light music		
CLASSICS:	Classical music		
OTHER M:	Other music		
WEATHER:	Weather information		
FINANCE:	Reports on commerce, trading, the Stock Market, etc.		
CHILDREN:	Entertainment programmes for children		

TROUBLESHOOTING



What appears to be trouble is not always serious. Check the following points before calling a service centre.

Symptoms	Causes	Remedies
<ul style="list-style-type: none"> • CD cannot be played back. 	CD is inserted upside down.	Insert the CD correctly.
<ul style="list-style-type: none"> • CD sound is sometimes interrupted. 	You are driving on rough roads.	Stop CD play while driving on rough roads.
	CD is scratched.	Change the CD.
	Connections are incorrect.	Check the cords and connections.
<ul style="list-style-type: none"> • Sound cannot be heard from the speakers. 	The volume level is set to the minimum level.	Adjust it to the optimum level.
	Connections are incorrect.	Check the cords and connections.
<ul style="list-style-type: none"> • SSM (Strong-station Sequential Memory) automatic preset does not work. 	Signals are too weak.	Store stations manually.
<ul style="list-style-type: none"> • Static noise while listening to the radio. 	The antenna is not connected firmly.	Connect the antenna firmly.
<ul style="list-style-type: none"> • “NO DISC” appears on the display. 	No CD is in the magazine.	Insert CD.
<ul style="list-style-type: none"> • “RESET 8” appears on the display. 	This unit is not connected to a CD changer correctly.	Connect this unit and the CD changer correctly and press the reset button of the CD changer.
<ul style="list-style-type: none"> • “RESET 1” – “RESET 7” appears on the display. 	_____	Press the reset button of the CD changer.
<ul style="list-style-type: none"> • “EJECT ERR” appears on the display and CD cannot be ejected. 	The CD player may function incorrectly.	Press and hold ⏪ ⏩ for more than 5 seconds.
<ul style="list-style-type: none"> • No message appears on the display but CD cannot be ejected. 		While holding ⏪ ⏩ , press the reset button. Release the reset button, then release ⏪ ⏩ . (Be careful not to drop the CD when ejecting.)
<ul style="list-style-type: none"> • “* * * *” appears on the display. 	Security lock is in use.	Enter the password. (See page 28.)
<ul style="list-style-type: none"> • This unit does not work at all. • The CD changer does not work at all. 	The built-in microcomputer may function incorrectly due to noise, etc.	Press the reset button on the front panel. (See page 2.)



Handling CDs

This unit has been designed to reproduce the CDs bearing the following marks.



You can play back your original CD-Rs (Recordable) and CD-RWs (Rewritable) on this receiver.

This unit is not compatible with MP3.

How to handle CDs

When removing a CD from its case, press down the center holder of the case and lift the CD out, holding it by the edges.

- Always hold the CD by the edges. Do not touch its recording surface.

When storing a CD into its case, gently insert the CD around the center holder (with the printed surface facing up).

- Make sure to store CDs into the cases after use.

Center holder

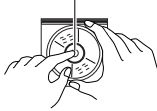

To keep CDs clean

A dirty CD may not play correctly. If a CD does become dirty, wipe it with a soft cloth in a straight line from center to edge.



To play new CDs

New CDs may have some rough spots around the inner and outer edges. If such a CD is used, this unit may reject the CD.

To remove these rough spots, rub the edges with a pencil or ball-point pen, etc.

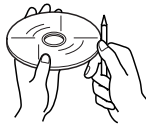

Moisture condensation

Moisture may condense on the lens inside the CD player in the following cases:

- After starting the heater in the car
 - If it becomes very humid inside the car
- Should this occur, the CD player may malfunction. In this case, eject the CD and leave the unit turned on for a few hours until the moisture evaporates.

When playing a CD-R or CD-RW

User-edited CD-Rs (Recordable) and CD-RWs (Rewritable) can be played back only if they are already “finalized.”

- You can play back your original CD-Rs or CD-RWs recorded in music CD format. (However, they may not be played back depending on their characteristics or recording conditions.)
- Before playing back CD-Rs or CD-RWs, read their instructions or cautions carefully.
- Some CD-Rs or CD-RWs may not be played back on this unit because of their disc characteristics, damage or stain on them, or if the player’s lens is dirty.
- CD-Rs or CD-RWs are susceptible to high temperatures or high humidity; so do not leave them inside your car.
- CD-RWs may require a longer readout time. (This is caused by the fact that the reflectance of CD-RWs is lower than for regular CDs.)

CAUTIONS:

- Do not insert 8 cm CDs (single CDs) into the loading slot. (Such CDs cannot be ejected.)
- Do not insert any CD of unusual shape – like a heart or flower; otherwise, it will cause a malfunction.
- Do not expose CDs to direct sunlight or any heat source or place them in a place subject to high temperature and humidity. Do not leave them in a car.
- Do not use any solvent (for example, conventional record cleaner, spray, thinner, benzine, etc.) to clean CDs.

About mistracking:

Mistracking may result from driving on extremely rough roads. This does not damage the unit and the CD, but will be annoying.

We recommend that you stop CD play while driving on such rough roads.

AUDIO AMPLIFIER SECTION

Maximum Power Output:

Front: 50 W per channel

Rear: 50 W per channel

Continuous Power Output (RMS):

Front: 19 W per channel into 4 Ω, 40 Hz to 20 000 Hz at no more than 0.8% total harmonic distortion.

Rear: 19 W per channel into 4 Ω, 40 Hz to 20 000 Hz at no more than 0.8% total harmonic distortion.

Load Impedance: 4 Ω (4 Ω to 8 Ω allowance)

Tone Control Range:

Bass: ±10 dB at 100 Hz

Treble: ±10 dB at 10 kHz

Frequency Response: 40 Hz to 20 000 Hz

Signal-to-Noise Ratio: 70 dB

Line-Out Level/Impedance:

2.0 V/20 kΩ load (full scale)

Output Impedance: 1 kΩ

TUNER SECTION

Frequency Range:

FM: 87.5 MHz to 108.0 MHz

AM: (MW) 522 kHz to 1 620 kHz

(LW) 144 kHz to 279 kHz

[FM Tuner]

Usable Sensitivity: 11.3 dBf (1.0 μV/75 Ω)

50 dB Quieting Sensitivity:

16.3 dBf (1.8 μV/75 Ω)

Alternate Channel Selectivity (400 kHz):

65 dB

Frequency Response: 40 Hz to 15 000 Hz

Stereo Separation: 30 dB

Capture Ratio: 1.5 dB

[MW Tuner]

Sensitivity: 20 μV

Selectivity: 35 dB

[LW Tuner]

Sensitivity: 50 μV

CD PLAYER SECTION

Type: Compact disc player

Signal Detection System: Non-contact optical pickup (semiconductor laser)

Number of channels: 2 channels (stereo)

Frequency Response: 5 Hz to 20 000 Hz

Dynamic Range: 96 dB

Signal-to-Noise Ratio: 98 dB

Wow and Flutter: Less than measurable limit

GENERAL

Power Requirement:

Operating Voltage: DC 14.4 V

(11 V to 16 V allowance)

Grounding System: Negative ground

Allowable Operating Temperature:

0°C to +40°C

Dimensions (W × H × D):

Installation Size:

182 mm × 52 mm × 160 mm

Panel Size:

188 mm × 58 mm × 8 mm

Mass: 1.7 kg (excluding accessories)

Design and specifications subject to change without notice.

Having TROUBLE with operation?

Please reset your unit

Refer to page of How to reset your unit

Haben Sie PROBLEME mit dem Betrieb?

Bitte setzen Sie Ihr Gerät zurück

Siehe Seite Zurücksetzen des Geräts

Vous avez des PROBLÈMES de fonctionnement?

Réinitialisez votre appareil

Référez-vous à la page intitulée Comment réinitialiser votre appareil

Hebt u PROBLEMEN met de bediening?

Stel het apparaat terug

Zie de pagina met de paragraaf Het apparaat terugstellen

JVC

VICTOR COMPANY OF JAPAN, LIMITED

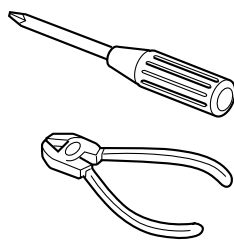

ENGLISH

- This unit is designed to operate on 12 V DC, NEGATIVE ground electrical systems.

INSTALLATION (IN-DASH MOUNTING)

- The following illustration shows a typical installation. However, you should make adjustments corresponding to your specific car. If you have any questions or require information regarding installation kits, consult your JVC IN-CAR ENTERTAINMENT dealer or a company supplying kits.

- Remove the trim plate.
- Remove the sleeve after disengaging the sleeve locks.
 - Stand the unit.

Note: When you stand the unit, be careful not to damage the fuse on the rear.
 - Insert the 2 handles between the unit and the sleeve, as illustrated, to disengage the sleeve locks.
 - Remove the sleeve.

Note: Be sure to keep the handles for future use after installing the unit.
- Attach the trim plate.
- Install the sleeve into the dashboard.

* After the sleeve is correctly installed into the dashboard, bend the appropriate tabs to hold the sleeve firmly in place, as illustrated.
- Fix the mounting bolt to the rear of the unit's body and place the rubber cushion over the end of the bolt.
- Do the required electrical connections.
- Slide the unit into the sleeve until it is locked by pressing the four corners of the trim plate.

Note: Do not press the panel (shaded in the illustration); otherwise, the panel may become unable to open or close.

DEUTSCH

- Dieses Gerät ist für einen Betrieb in elektrischen Anlagen mit 12 V Gleichstrom und (-) Erdung ausgelegt.

EINBAU (IM ARMATURENBRETT)

- Die folgende Abbildung zeigt einen typischen Einbau. Dennoch müssen Sie entsprechend Ihrem jeweiligen Auto Anpassungen vornehmen. Bei irgendwelchen Fragen oder wenn Sie Informationen hinsichtlich des Einbausatzes brauchen, wenden Sie sich an ihren JVC Autoradiohändler oder ein Unternehmen das diese Einbausätze vertreibt.

- Den Frontrahmen herausnehmen.
- Die Halterung nach dem Entriegeln der Halterungssperren herausnehmen.
 - Das Gerät aufstellen.

Hinweis: Beim Aufstellen des Geräts darauf achten, daß die Sicherung auf der Rückseite nicht beschädigt wird.
 - Die 2 Griffe zwischen dem Gerät und der Halterung wie abgebildet einstecken und die Halterungssperren entriegeln.
 - Die Halterung herausnehmen.

Hinweis: Sicherstellen, daß die Griffe für künftigen Gebrauch nach dem Einbau des Geräts aufbewahrt werden.
- Befestigen Sie die Frontrahmen.
- Die Halterung im Armaturenbrett einbauen.

* Nach dem korrekten Einbau der Halterung im Armaturenbrett, die entsprechenden Riegel umknicken, um die Halterung an ihrem Platz zu sichern, siehe Abbildung.
- Die Befestigungsschraube an der Rückseite des Gerätekörpers befestigen und das Ende der Schraube mit einem Gummipuffer abdecken.
- Nehmen Sie die erforderlichen elektrischen Anschlüsse vor.
- Schieben Sie das Gerät in die Halterung. Das Gerät wird verriegelt, indem Sie auf die vier Ecken des Frontrahmen drücken.

Hinweis: Drücken Sie nicht auf die Blende (die in der Abbildung dunkelgetönt dargestellt ist); anderenfalls läßt sich die Blende weder öffnen noch schließen.

FRANÇAIS

- Cet appareil est conçu pour fonctionner sur des sources de courant continu de 12 V à masse NEGATIVE.

INSTALLATION (MONTAGE DANS LE TABLEAU DE BORD)

- L'illustration suivante est un exemple d'installation typique. Cependant, vous devez faire les ajustements correspondant à votre voiture particulière. Si vous avez des questions ou avez besoin d'information sur des kits d'installation, consulter votre revendeur d'autoradios JVC ou une compagnie d'approvisionnement.

- Retirer la plaque d'assemblage.
- Libérer les verrous du manchon et retirer le manchon.
 - Poser l'appareil à la verticale.

Remarque: Lorsque vous mettez l'appareil à la verticale, faire attention de ne pas endommager le fusible situé sur l'arrière.
 - Insérer les 2 poignées entre l'appareil et le manchon comme indiqué pour désengager les verrous de manchon.
 - Retirer le manchon.

Remarque: S'assurer de garder les poignées pour une utilisation ultérieure, après l'installation de l'appareil.
- Attachez la plaque d'assemblage.
- Installer le manchon dans le tableau de bord.

* Après installation correcte du manchon dans le tableau de bord, plier les bonnes pattes pour maintenir fermement le manchon en place, comme montré.
- Monter le boulon de montage sur l'arrière du corps de l'appareil puis passer l'amortisseur en caoutchouc sur l'extrémité du boulon.
- Réalisez les connexions électriques.
- Faire glisser l'appareil dans le manchon jusqu'à ce qu'il soit verrouillé en appuyant sur les quatre coins de la plaque d'assemblage.

Remarque: N'appuyez pas sur le panneau (ombré sur l'illustration); sinon le panneau risquerait de ne pas pouvoir s'ouvrir ou se fermer.

NEDERLANDS

- Dit apparaat mag worden gebruikt bij elektrische systemen die werken op 12 V gelijkstroom met negatieve aarding.

INSTALLATIE (INBOUW IN HET DASHBOARD)

- Op de volgende afbeelding kunt u zien hoe de installatie, normaal gesproken, in zijn werk gaat. U moet echter bij de installatie rekening houden met de bijzonderheden van uw eigen auto. Neem bij vragen of voor meer bijzonderheden over inbouwpakketten contact op met uw JVC car audio dealer of een dealer of een bedrijf dat inbouwpakketten levert.

- Verwijder de sierplaat.
- Verwijder het huis nadat u de klemmen hebt losgemaakt.
 - Zet het apparaat rechtop.

Opmerking: Wanneer u het apparaat rechtop zet, moet u erop letten dat u de zekering aan de achterkant niet beschadigt.
 - Plaats de 2 hendels, zoals afgebeeld, tussen het apparaat en het huis, om de klemmen los te maken.
 - Verwijder het huis.

Opmerking: Bewaar de hendels nadat u het apparaat hebt geïnstalleerd, zodat u ze ook in de toekomst kunt gebruiken.
- Bevestig de sierplaat.
- Installeer het huis in het dashboard.

* Nadat het huis op de juiste wijze in het dashboard is geplaatst, moet u de palletjes, zoals afgebeeld, stevig op hun plaats duwen.
- Maak de bevestigingsbout aan de achterkant van het apparaat vast en plaats de rubberdop over het uiteinde van de bout.
- Breng de vereiste elektrische verbindingen tot stand.
- Schuif het apparaat in het huis totdat het vergrendeld is, kunt u deze vastzetten door op de vier hoeken van de sierplaat te drukken.

Opmerking: Druk niet op het paneel zelf (gearceerd weergegeven in de illustratie); anders kunt u het paneel zodanig beschadigen dat dit niet meer kan worden geopend en gesloten.

1

Trim plate
Frontrahmen
Plaque d'assemblage
Sierplaat

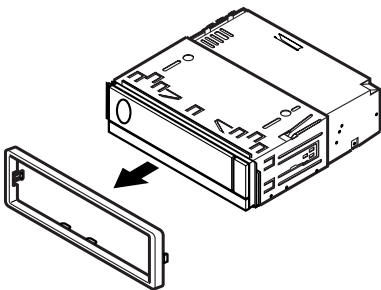

2

Handle
Griff
Poignée
Hendel

Slot
Schlitz
Fente
Sleuf

Fuse
Sicherung
Fusible
Zekering

Lock Plate
Arretierplättchen
Plaque de verrouillage
Vergrendelingsplaat

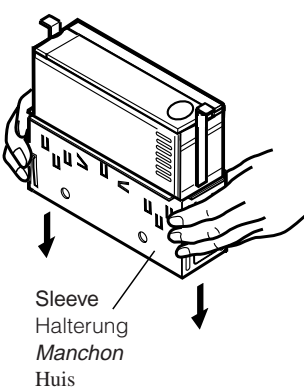

Sleeve
Halterung
Manchon
Huis

3

Trim plate
Frontrahmen
Plaque d'assemblage
Sierplaat

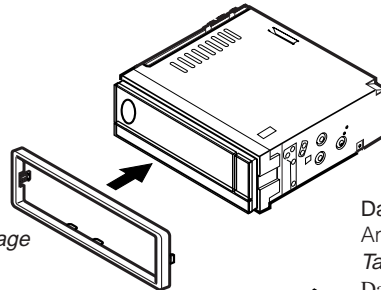

Dashboard
Armaturenbrett
Tableau de bord
Dashboard

Rubber cushion
Gummipuffer
Amortisseur en caoutchouc
Rubberdop

Sleeve
Halterung
Manchon
Huis

Mounting bolt
Befestigungsschraube
Boulon de montage
Bevestigingsbout

6 See "ELECTRICAL CONNECTIONS."
Siehe „ELEKTRISCHE ANSCHLÜSSE“.
Référez-vous "RACCORDEMENTS
ELECTRIQUES".
Zie "ELEKTRISCHE VERBINDINGEN".

TROUBLESHOOTING

- The fuse blows.**
 - Are the red and black leads connected correctly?
- Power cannot be turned on.**
 - Is the yellow lead connected?
- No sound from the speakers.**
 - Is the speaker output lead short-circuited?
- Sound is distorted.**
 - Is the speaker output lead grounded?
 - Are the "-" terminals of L and R speakers grounded in common?
- Unit becomes hot.**
 - Is the speaker output lead grounded?
 - Are the "-" terminals of L and R speakers grounded in common?

FEHLERSUCHE

- Die Sicherung brennt durch.**
 - Sind die roten und schwarzen Leitungen richtig angeschlossen?
- Stromversorgung kann nicht eingeschaltet werden.**
 - Ist die gelbe Leitung angeschlossen?
- Kein Ton aus den Lautsprechern.**
 - Ist die Lautsprecherausgangsleitung kurzgeschlossen?
- Ton verzerrt.**
 - Ist die Lautsprecherausgangsleitung geerdet?
 - Sind die (-) Anschlußklemmen der linken und rechten Lautsprecher zusammen geerdet?
- Gerät wird heiß.**
 - Ist die Lautsprecherausgangsleitung geerdet?
 - Sind die (-) Anschlußklemmen der linken und rechten Lautsprecher zusammen geerdet?

EN CAS DE DIFFICULTES

- Le fusible saute.**
 - Les fils rouge et noir sont-ils raccordés correctement?
- L'appareil ne peut pas être mise sous tension.**
 - Le fil jaune est-elle raccordée?
- Pas de son des enceintes.**
 - Le fil de sortie d'enceinte est-il court-circuité?
- Le son est déformé.**
 - Le fil de sortie d'enceinte est-il à la masse?
 - Les bornes "-" des enceintes gauche et droit sont-elles mises ensemble à la masse?
- L'appareil devient chaud.**
 - Le fil de sortie d'enceinte est-il à la masse?
 - Les bornes "-" des enceintes gauche et droit sont-elles mises ensemble à la masse?

PROBLEMEN OPLOSSEN

- De zekering slaat door.**
 - Zijn de rode en de zwarte draden op de juiste manier aangesloten?
- De stroom kan niet worden ingeschakeld.**
 - Is de gele draad aangesloten?
- Er komt geen geluid uit de speakers.**
 - Is de uitgaande speakerdraad kortgesloten?
- Het geluid wordt vervormd.**
 - Is de uitgaande speakerdraad geaard?
 - Zijn de minpolen van de linker- en de rechterspeakers gemeenschappelijk geaard?
- Het apparaat raakt verhit.**
 - Is de uitgaande speakerdraad geaard?
 - Zijn de minpolen van de linker- en de rechterspeakers gemeenschappelijk geaard?

- When using the optional stay
- Beim Verwenden der Anker-Option
- Lors de l'utilisation du hauban en option
- Wanneer u de steun gebruikt (facultatief)

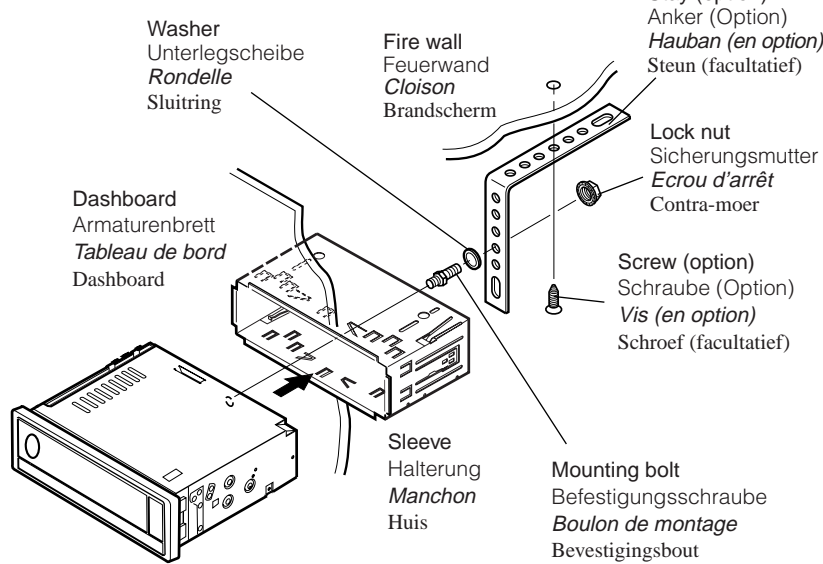

- When installing the unit without using the sleeve
- Beim Einbau des Geräts ohne Halterung
- Lors de l'installation de l'appareil sans utiliser de manchon
- Wanneer u het apparaat zonder huis installeert

In a Toyota for example, first remove the car radio and install the unit in its place.
Zum Beispiel in einem Toyota zuerst das Autoradio ausbauen und dann das Gerät an seinem Platz einbauen.
Par exemple dans une Toyota, retirer d'abord l'autoradio et installer l'appareil à la place.
Voorbeeld: Bij een Toyota moet u eerst de autoradio verwijderen en daarna het apparaat installeren.

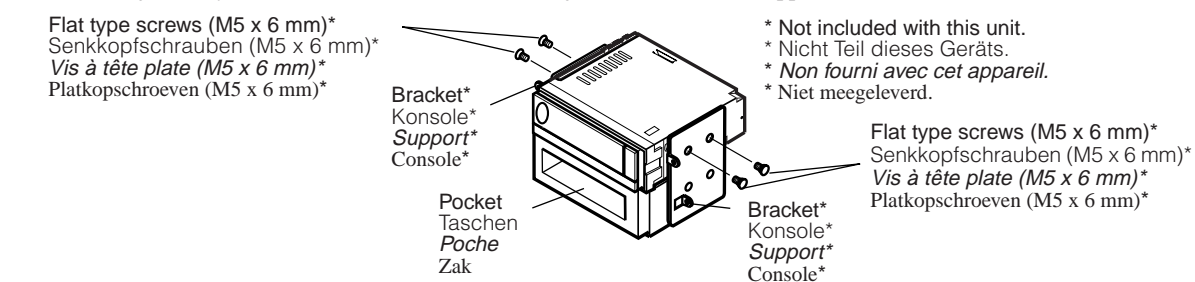

Note: When installing the unit on the mounting bracket, make sure to use the 6 mm-long screws. If longer screws are used, they could damage the unit.

Hinweis: Beim Anbringen des Gerät an der Konsole sicherstellen, daß 6 mm lange Schrauben verwendet werden. Werden längere Schrauben verwendet, können sie das Gerät beschädigen.

Remarque: Lors de l'installation de l'appareil sur le support de montage, s'assurer d'utiliser des vis d'une longueur de 6 mm. Si des vis plus longues sont utilisées, elles peuvent endommager l'appareil.

Opmerking: Wanneer u het apparaat aan de bevestigingsklem vastmaakt, moet u de 6 mm lange schroeven gebruiken. Als u langere schroeven gebruikt, kan het apparaat worden beschadigd.

Removing the unit

• Before removing the unit, release the rear section.

- 1 Remove the trim plate.
- 2 Insert the 2 handles into the slots, as shown. Then, while gently pulling the handles away from each other, slide out the unit. **(Be sure to keep the handles after installing it.)**

Ausbau des Geräts

• Vor dem Ausbau des Geräts den hinteren Teil freigeben.

- 1 Den Frontrahmen herausnehmen.
- 2 Die 2 Griffe in die Schlitzte wie gezeigt stecken. Dann die Griffe behutsam auseinander ziehen und das Gerät herausziehen. **(Die Griffe nach dem Einbau auf jeden Fall aufbewahren.)**

Retrait de l'appareil

• Avant de retirer l'appareil, libérer la section arrière.

- 1 Retirer la plaque d'assemblage.
- 2 Introduire les 2 poignées dans les fentes, comme montré. Puis, tout en tirant doucement les poignées écartées, faire glisser l'appareil pour le sortir. **(S'assurer de conserver les poignées après l'installation de l'appareil.)**

Verwijderen van het apparaat

• Voordat u het apparaat verwijdert, moet u het achtergedeelte losmaken.

- 1 Verwijder de sierplaat.
- 2 Plaats de 2 hendels, zoals afgebeeld, in de sleuven. Daarna duwt u de hendels zachtjes uit elkaar en kunt u het apparaat naar buiten schuiven. **(Bewaar de hendels nadat u het apparaat hebt geïnstalleerd!)**

1

Trim plate
Frontrahmen
Plaque d'assemblage
Sierplaat

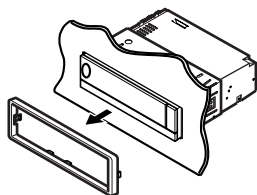

2

Handle
Griff
Poignée
Hendel

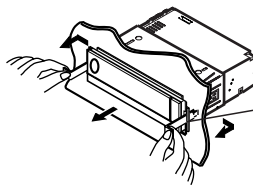

Parts list for installation and connection

The following parts are provided with this unit. After checking them, please set them correctly.

Teilliste für den Einbau und Anschluß

Die folgenden Teile werden zusammen mit diesem Gerät geliefert. Nach ihrer Überprüfung, die Teile richtig einsetzen.

Liste des pièces pour l'installation et raccordement

Les pièces suivantes sont fournies avec cet appareil. Après vérification, veuillez les placer correctement.

Lijst van onderdelen die u bij installatie en aansluiting nodig hebt

De volgende onderdelen worden bij het apparaat geleverd. Installeer ze op de juiste wijze, nadat u ze hebt gecontroleerd.

Sleeve
Halterung
Manchon
Huis

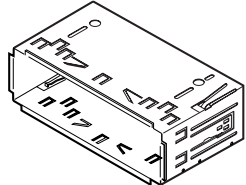

Trim plate
Frontrahmen
Plaque d'assemblage
Sierplaat

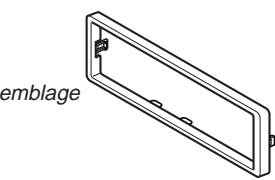

Handles
Griffe
Poignées
Hendels

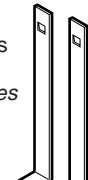

Power cord
Stromkabel
Cordon d'alimentation
Stroomkabel

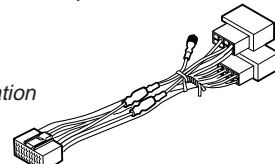

Remote controller
Fernbedienung
Télécommande
Afstandsbediening

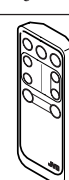

Battery
Batterie
Pile
Batterij



CR2025

Washer (ø5)
Unterlegscheibe (ø5)
Rondelle (ø5)
Sluitering (ø5)



Lock nut (M5)
Sicherungsmutter (M5)
Ecrou d'arrêt (M5)
Contra-moer (M5)



Mounting bolt (M5 x 20 mm)
Befestigungsschraube (M5 x 20 mm)
Boulon de montage (M5 x 20 mm)
Bevestigingsbout (M5 x 20 mm)



Rubber cushion
Gummipuffer
Amortisseur en caoutchouc
Rubberdop



For KD-LX330R only
Nur für den KD-LX330R
Pour le KD-LX330R seulement
Alleen voor KD-LX330R

ELECTRICAL CONNECTIONS

ELEKTRISCHE ANSCHLÜSSE

RACCORDEMENTS ELECTRIQUES

ELEKTRISCHE VERBINDINGEN

To prevent short circuits, we recommend that you disconnect the battery's negative terminal and make all electrical connections before installing the unit. If you are not sure how to install this unit correctly, have it installed by a qualified technician.

Zur Vermeidung von Kurzschlüssen empfehlen wir, daß Sie den negativen Batterieanschluß abtrennen und alle elektrischen Anschlüsse herstellen, bevor das Gerät eingebaut wird. Sind Sie sich über den richtigen Einbau des Geräts nicht sicher, lassen Sie es von einem qualifizierten Techniker einbauen.

Pour éviter tout court-circuit, nous vous recommandons de débrancher la borne négative de la batterie et d'effectuer tous les raccordements électriques avant d'installer l'appareil. Si l'on n'est pas sûr de pouvoir installer correctement cet appareil, le faire installer par un technicien qualifié.

Om kortsluiting te voorkomen adviseren wij u om de minpool van de accu los te maken en alle elektrische verbindingen tot stand te brengen voordat u het apparaat in de auto installeert. Als u niet zeker weet hoe u dit apparaat moet installeren, kunt u dit beter door een daartoe gekwalificeerde technicus laten doen.

Note:

This unit is designed to operate on 12 V DC, **NEGATIVE ground electrical systems**. If your vehicle does not have this system, a voltage inverter is required, which can be purchased at JVC IN-CAR ENTERTAINMENT dealers.

- Replace the fuse with one of the specified rating. If the fuse blows frequently, consult your JVC IN-CAR ENTERTAINMENT dealer.
- If noise is a problem... This unit incorporates a noise filter in the power circuit. However, with some vehicles, clicking or other unwanted noise may occur. If this happens, connect the unit's rear ground terminal (see connection diagram) to the car's chassis using shorter and thicker cords, such as copper braiding or gauge wire. If noise still persists, consult your JVC IN-CAR ENTERTAINMENT dealer.
- Maximum input of the speakers should be no more than 50 W at the rear and 50 W at the front, with an impedance of 4 Ω to 8 Ω.
- **Be sure to ground this unit to the car's chassis.**
- The heat sink becomes very hot after use. Be careful not to touch it when removing this unit.

Hinweis:

Dieses Gerät ist für einen Betrieb in **elektrischen Anlagen mit 12 V Gleichstrom und (-) Erdung** ausgelegt. Verfügt Ihr Fahrzeug nicht über diese Anlage, ist ein Spannungsinverter erforderlich, der bei JVC Autoradiohändler erworben werden kann.

- Die Sicherung mit einer der entsprechenden Nennleistung ersetzen. Brennt die Sicherung häufig durch, wenden Sie sich an ihren JVC Autoradiohändler.
- Sind Störgeräusche ein Problem... Dieses Gerät enthält ein Störfilter im Stromkreis. Bei manchen Fahrzeugen kann jedoch ein Klicken oder andere unerwünschte Störgeräusche auftreten. Sollte das der Fall sein, die **hintere Erdungscanschlussklemme** (siehe Schaltplan) des Geräts am Fahrwerk des Fahrzeugs anschließen, dabei kürzere und dickere Kabel wie beispielsweise Kupfergeflecht oder Stahldraht verwenden. Bleibt Störgeräusch bestehen, wenden Sie sich an Ihren JVC Autoradiohändler.
- Maximale Eingangsleistung der Lautsprecher sollte nicht mehr als 50 W hinten und 50 W vorne sein, mit einer Impedanz von 4 Ω bis 8 Ω.
- **Sicherstellen, daß das Gerät am Fahrwerk geerdet wird.**
- Das Abstrahlblech wird nach dem Gebrauch sehr heiß. Beim Ausbau des Geräts darauf achten, das Abstrahlblech nicht zu berühren.

Remarque:

Cet appareil est conçu pour fonctionner sur des sources de courant continu de 12 V à masse **NEGATIVE**. Si votre véhicule n'offre pas ce type d'alimentation, il vous faut un convertisseur de tension, que vous pouvez acheter chez un revendeur d'autoradios JVC.

- Remplacer le fusible par un de la valeur précisée. Si le fusible saute souvent, consulter votre revendeur d'autoradios JVC.
- Si le bruit est un problème... Cet appareil incorpore un filtre de bruit dans le circuit d'alimentation. Cependant, avec certains véhicules, quelques claquements ou autres bruits non désirés risquent de se produire. Si cela arrive, raccorder la borne arrière de masse de l'appareil au châssis de la voiture (voir le diagramme de raccordement) en utilisant des cordons les plus gros et les plus courts possibles telle qu'une barre de cuivre ou une tresse. Si le bruit persiste, consulter votre revendeur d'autoradios JVC.
- La puissance admissible des enceintes devrait n'être pas plus qu'c 50 W à l'arrière et à 50 W l'avant, avec une impédance de 4 Ω à 8 Ω.
- **S'assurer de raccorder la mise à la masse de cet appareil au châssis de la voiture.**
- Le dissipateur de chaleur devient très chaud après usage. Faire attention de ne pas le toucher en retirant cet appareil.

Opmerking:

Dit apparaat mag worden gebruikt bij elektrische systemen die werken op 12 V gelijkstroom met **negatieve aarding**. Als uw auto niet is uitgerust met een dergelijk systeem, is een spanningsomzetter vereist. Dit instrument kan worden aangeschaft bij JVC car audio dealers.

- Vervang de zekering door een exemplaar met het aangegeven vermogen. Als de zekering vaak doorslaat, moet u uw JVC car audio dealer raadplegen.
- Als u geluidsproblemen hebt... De krachtschakeling van dit apparaat heeft een ingebouwd geluidsfilter. In sommige voertuigen zijn tikgeluiden of andere ongewenste geluiden te horen. Als dit gebeurt, moet u de **massaklem aan de achterkant** (zie aansluitingsschema) aan het chassis van de auto vastmaken met behulp van een kortere en dikkere kabel, zoals kopermanteldraad of tellerkabel. Als het geluid niet verdwijnt, moet u contact opnemen met uw JVC car audio dealer.
- Het maximum ingangsvermogen van de speakers moet achterin niet meer dan 50 W zijn en voorin 50 W, met een impedantie van 4 Ω tot 8 Ω.
- **Zorg ervoor dat dit apparaat door middel van een aardkabel is verbonden met het chassis van de auto.**
- De warmte-opnemer kan na gebruik erg heet worden. Raak de warmte-opnemer niet aan wanneer u dit apparaat van zijn plaats haalt.

Heat sink
Abstrahlblech
Dissipateur de chaleur
Warmte-opnemer

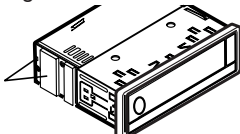

Connecting the leads / Anschließen der Leitungen / Raccordement des fils / Aansluiting van de gekleurde draden

Twist the core wires when connecting.

Die Kerndrähte beim Anschließen verdrehen.
Torsader les âmes des fils en les raccordant.

Draai de kerndraden om elkaar heen wanneer u ze wilt aansluiten.

Solder the core wires to connect them securely.

Die Kerndrähte anlöten, um sie fest anzuschließen.

Souder les âmes des fils pour les raccorder entre eux de façon sûre.
Soldeer de kerndraden zodat ze stevig vast zitten.

CAUTION / VORSICHT / PRECAUTION / LET OP!

- To prevent short-circuit, cover the terminals of the **UNUSED** leads with insulating tape.
- Zur Vermeidung eines Kurzschlusses die **ANSCHLUßKLEMMEN** der **NICHT VERWENDETEN** Leitungen mit Isolierklebeband umwickeln.
- Pour éviter les court-circuits, couvrir les bornes des fils qui ne sont **PAS** utilisés avec de la bande isolante.
- Om kortsluiting te voorkomen, moet u de aansluitklemmen van **ONGEBRUIKTE** gekleurde draden met isolatieband bedekken.

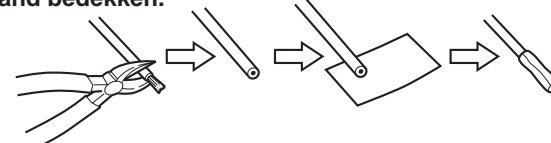

A If your car is equipped with the ISO connector
Wenn Ihr Auto mit ISO-Steckern ausgestattet ist
Si votre voiture est équipée d'un connecteur ISO
Indien uw auto is uitgerust met de ISO-connector

- Connect the ISO connectors as illustrated.
- Die ISO-Stecker wie abgebildet anschließen.
- *Connectez les connecteurs ISO comme montré sur l'illustration.*
- Sluit de ISO-connectoren aan zoals op het voorbeeld is aangegeven.

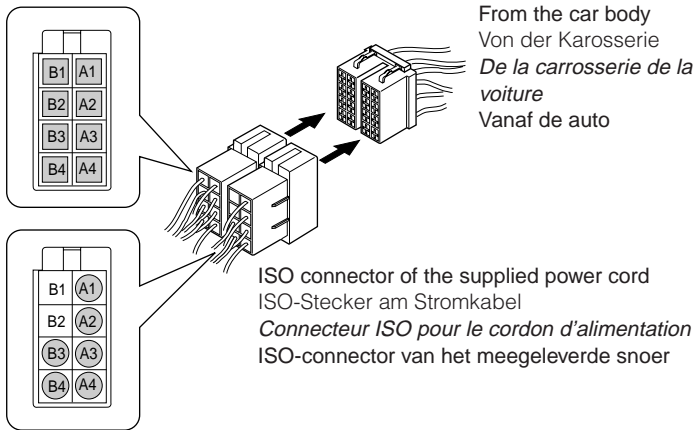

From the car body
 Von der Karosserie
 De la carrosserie de la voiture
 Vanaf de auto

ISO connector of the supplied power cord
 ISO-Stecker am Stromkabel
 Connecteur ISO pour le cordon d'alimentation fourni
 ISO-connector van het meegeleverde snoer

View from the lead side
 Ansicht von der Leitungsseite
 Vue à partir du côté des fils
 Aanzicht vanaf het snoer

For some VW/Audi or Opel (Vauxhall) automobile
Für manche VW/Audi oder Opel (Vauxhall) Fahrzeuge
Pour certaine voiture VW/Audi ou Opel (Vauxhall)
Voor bepaalde modellen VW/Audi of Opel (Vauxhall) geldt

- You may need to modify the wiring of the supplied power cord as illustrated.
- Contact your authorized car dealer before installing this unit.
 - Sie müssen evtl. die Verdrahtung des mitgelieferten Stromkabels wie abgebildet ändern.
 - Wenden Sie sich an Ihre Vertragswerkstatt, bevor Sie das Gerät einbauen.
 - *Vous aurez peut-être besoin de modifier le câblage du cordon d'alimentation fourni comme montré sur l'illustration.*
 - *Contactez votre revendeur automobile autorisé avant d'installer l'appareil.*
- Wellicht moet u de bedrading van het meegeleverde snoer als in het voorbeeld aanpassen.
- Neem contact op met uw officiële autodealer alvorens dit apparaat te installeren.

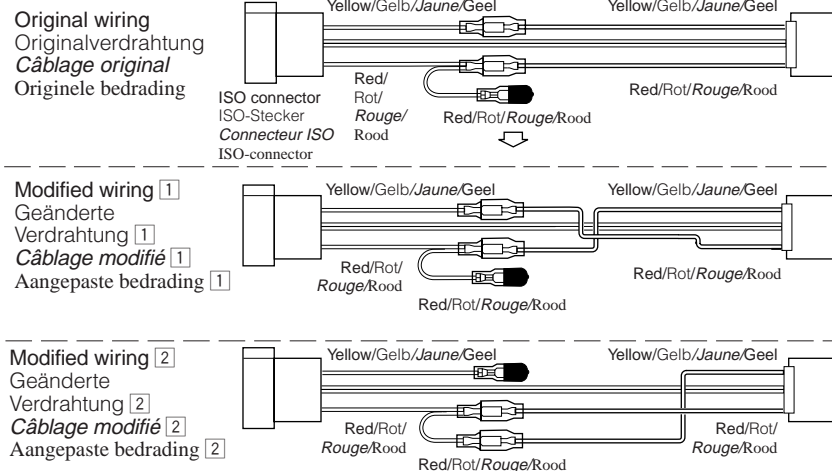

Use modified wiring [2] if the unit does not turn on.
 Geänderte Verdrahtung [2] verwenden, wenn das Gerät so nicht an geht.
Utilisez le câblage modifié [2] si l'appareil ne se met pas sous tension.
 Pas de bedrading [2] aan indien het apparaat niet reageert bij inschakelen.

B Connections without using the ISO connectors / Anschlüsse ohne ISO-Stecker / Connexions sans l'utilisation des connecteurs ISO / Verbindingen zonder ISO-connectoren

Before connecting: Check the wiring in the vehicle carefully. Incorrect connection may cause serious damage to this unit.

- 1 Cut the ISO connector.
- 2 Connect the colored leads of the power cord to the car battery, speakers and power aerial (if any) in the following sequence.
 - 1 Black: ground
 - 2 Yellow: to car battery (constant 12 V)
 - 3 Red: to an accessory terminal
 - 4 Blue with white stripe: to power aerial (200 mA max.)
 - 5 Orange with white stripe: to car light control switch
 - 6 Brown: to cellular phone system (For details, refer to the instructions of the cellular phone.)
 - 7 Others: to speakers
- 3 Connect the aerial cord.
- 4 Finally connect the wiring harness to the unit.

Vor dem Anschließen: Die Verdrahtung im Fahrzeug sorgfältig überprüfen. Falsche Anschlüsse können ernsthafte Schäden am Gerät hervorrufen.

- 1 Den ISO-Stecker abschneiden.
- 2 Die farbigen Leitungen des Spannungsversorgungskabels an der Autobatterie, den Lautsprechern und dem Motorantenne (sofern vorhanden) in folgender Reihenfolge anschließen.
 - 1 Schwarz: Erdung
 - 2 Gelb: an Autobatterie (konstant 12 V)
 - 3 Rot: zur einer Zubehöransteckklammer
 - 4 Blau mit weißem Streifen: zur Motorantenne (max. 200 mA)
 - 5 Orange mit weißem Streifen: zur Autolichtschalter
 - 6 Braun: zur Mobiltelefon (Weitere Informationen entnehmen Sie bitte der Bedienungsanleitung des Mobiltelefons.)
 - 7 Andere: zur Lautsprecher
- 3 Das Antennenkabel anschließen.
- 4 Die Kabelbäume am Gerät anschließen.

Avant de commencer la connexion: Vérifiez attentivement le câblage du véhicule. Une connexion incorrecte peut endommager sérieusement l'appareil.

- 1 Coupez le connecteur ISO.
- 2 Connectez les fils de couleur du cordon d'alimentation à la batterie de la voiture, aux enceintes et à l'antenne automatique (s'il y en a une) dans l'ordre suivant.
 - 1 Noir: à la masse
 - 2 Jaune: à la batterie de la voiture (12 V constant)
 - 3 Rouge: à une borne accessoire
 - 4 Bleu avec bande blanche: à l'antenne automatique (200 mA max.)
 - 5 Orange avec bande blanche: à l'interrupteur d'éclairage de la voiture
 - 6 Marron: à un système de téléphone cellulaire (Pour les détails, se référer aux instructions du téléphone cellulaire.)
 - 7 Autres: aux enceintes
- 3 Connectez le cordon d'antenne.
- 4 Finalement, connectez le faisceau de fils à l'appareil.

Alvorens de verbindingen tot stand te brengen: Moet u de bedrading in de auto zorgvuldig. Het apparaat kan door verkeerde verbindingen ernstige schade oplopen.

- 1 Knip de ISO-connector los.
- 2 Sluit de gekleurde snoerdraden van de stroomkabel in de hierna genoemde volgorde aan op de accu van de auto, de luidsprekers en de antenne (indien aanwezig).
 - 1 Zwart: aarde
 - 2 Geel: naar de accu van de auto (constant 12 V)
 - 3 Rood: naar de aansluitklem van de accessoire
 - 4 Blauw met witte streep: naar de antenne (Max. 200 mA)
 - 5 Oranje met witte streep: naar de schakelaar voor de autoverlichting
 - 6 Bruin: naar het mobiele-telefoonsysteem (Lees voor meer informatie de instructies die bij de mobiele telefoon worden geleverd.)
 - 7 Andere: naar de speakers
- 3 Sluit de antenne aan.
- 4 Verbind de draadbundel daarna met het apparaat.

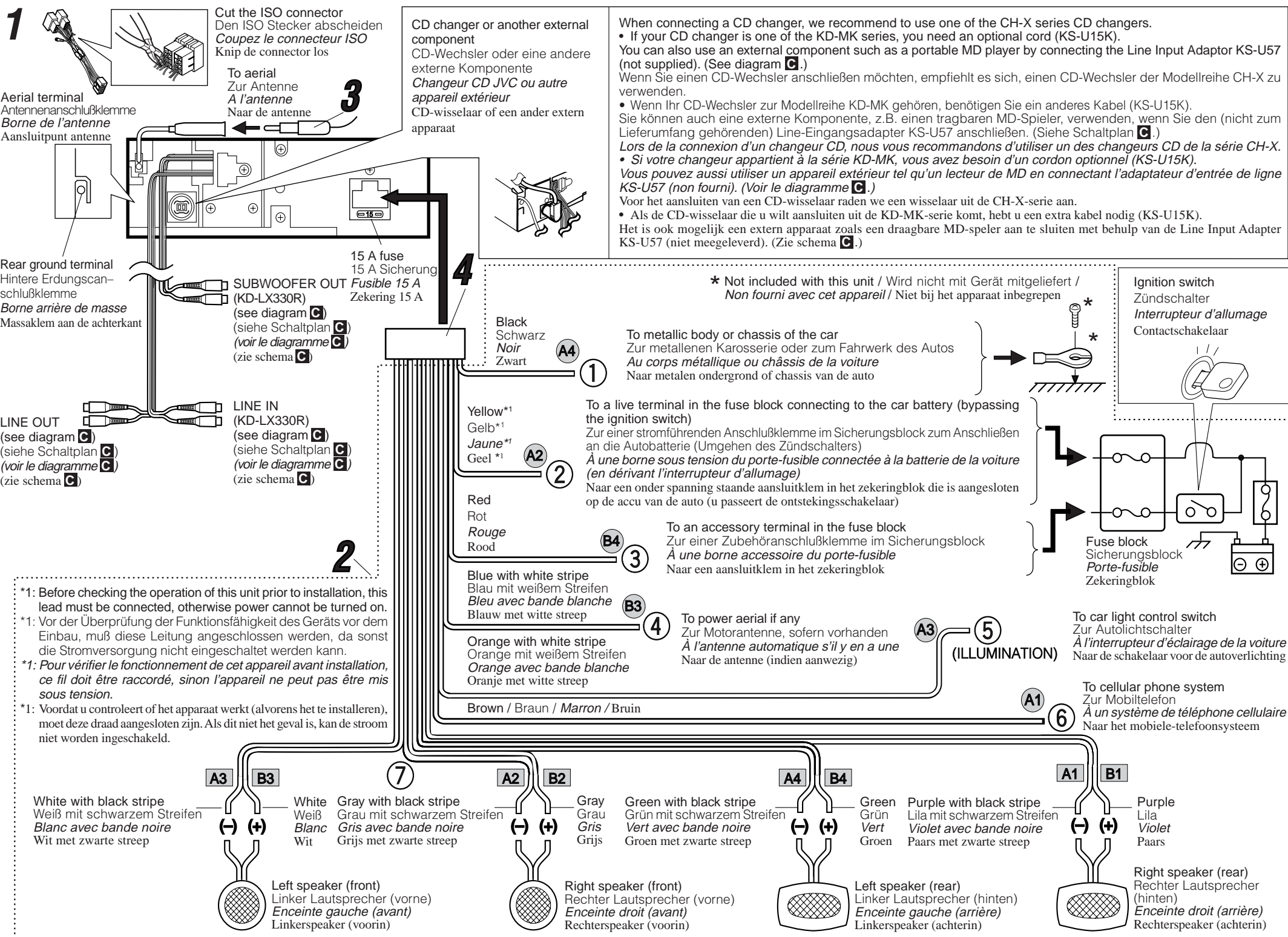

PRECAUTIONS on power supply and speaker connections:

- DO NOT connect the speaker leads of the power cord to the car battery; otherwise, the unit will be seriously damaged.
- Connect the black lead (ground), yellow lead (to car battery, constant 12 V), and red lead (to an accessory terminal) correctly.
- BEFORE connecting the speaker leads of the power cord to the speakers, check the speaker wiring in your car.
 - If the speaker wiring in your car is as illustrated in Fig. 1 and Fig. 2 below, DO NOT connect the unit using that original speaker wiring. If you do, the unit will be seriously damaged.
 - Redo the speaker wiring so that you can connect the unit to the speakers as illustrated in Fig. 3.
 - If the speaker wiring in your car is as illustrated in Fig. 3, you can connect the unit using the original speaker wiring in your car.
 - If you are not sure of the speaker wiring of your car, consult your JVC IN-CAR ENTERTAINMENT dealer.

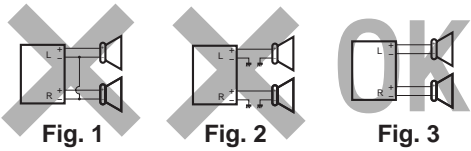

VORSICHTSMASSELN beim Anschließen der Stromversorgung und Lautsprecher:

- Die Lautsprecherleitungen des Netzkabels NICHT an der Autobatterie anschließen, da sonst das Gerät schwer beschädigt wird.
- Die schwarze Leitung (Erdung), die gelbe Leitung (zur Autobatterie, konstant 12 V) und die rote Leitung (zur Zubehöranschlussschleife) richtig anschließen.
- VOR dem Anschließen der Lautsprecherleitungen des Spannungsversorgungskabels an die Lautsprecher, die Lautsprecherverdrahtung in Ihrem Auto überprüfen.
 - Ist die Lautsprecherverdrahtung wie unten in "Fig. 1" und "Fig. 2" abgebildet, das Gerät NICHT mit der Originalverdrahtung der Lautsprecher anschließen, da sonst das Gerät schwer beschädigt wird.
 - Die Lautsprecherverdrahtung erneuern, so daß Sie das Gerät an den Lautsprechern wie in "Fig. 3" abgebildet anschließen können.
 - Ist die Lautsprecherverdrahtung in Ihrem Auto wie in "Fig. 3" abgebildet, können Sie das Gerät mit der Originalverdrahtung der Lautsprecher in Ihrem Auto anschließen.
 - Sind Sie sich über die Lautsprecherverdrahtung in Ihrem Auto nicht sicher, wenden Sie sich an Ihren Autohändler.

PRECAUTIONS sur l'alimentation et la connexion des enceintes:

- NE CONNECTEZ PAS les fils d'enceintes du cordon d'alimentation à la batterie; sinon, l'appareil serait sérieusement endommagé.
- Connectez correctement le fil noir (à la masse), le fil jaune (à la batterie de la voiture, 12 V constant) et le fil rouge (à la prise accessoire).
- AVANT de connecter les fils d'enceintes du cordon d'alimentation aux enceintes, vérifiez le câblage des enceintes de votre voiture.
 - Si le câblage des enceintes de votre voiture est comme montré sur la Fig. 1 ou Fig. 2 ci-dessous, NE CONNECTEZ PAS l'appareil en utilisant ce câblage original des enceintes. Si vous le faites, l'appareil sera sérieusement endommagé.
 - Recommencez le câblage des enceintes de façon que vous puissiez connecter l'appareil aux enceintes comme montré sur la Fig. 3.
 - Si le câblage des enceintes de votre voiture est comme montré sur la Fig. 3, vous pouvez connecter l'appareil en utilisant ce câblage original d'enceintes pour votre voiture.
 - Si vous n'êtes pas sûrs du câblage d'enceintes de votre voiture, consultez le concessionnaire de votre voiture.

VOORZORGSMAATREGELEN bij het verbinden van de stroomkabeldraad met de speakers:

- Verbind de speakerdraden van de stroomkabel NIET met de accu van de auto; als u dit wel doet, zal het apparaat ernstige schade oplopen.
- Sluit de zwarte draad (aarde), de gele draad (naar de accu van de auto, constant 12 V) en de rode draad (naar de aansluitklem van de accessoire) op de juiste wijze aan.
- VOORDAT u de speakerdraden van de stroomkabel met de speakers verbindt, moet u de bedrading van de speakers in uw auto controleren.
 - Als de bedrading van de speakers eruitziet zoals hieronder staat afgebeeld in Fig. 1 en Fig. 2, mag het apparaat NIET worden aangesloten met behulp van deze oorspronkelijke speakerbedrading. Als u dat wel doet, zal het apparaat ernstige schade oplopen.
 - Pas de bedrading van de speakers aan, zodat u het apparaat met de speakers kunt verbinden, zoals staat afgebeeld in Fig. 3.
 - Als de bedrading van de speakers eruitziet zoals staat afgebeeld in Fig. 3, kunt u het apparaat aansluiten met behulp van de oorspronkelijke speakerbedrading in uw auto.
 - Als u twijfels hebt over de speakerbedrading in uw auto, moet u contact opnemen met uw autodealer.

Connections Adding Other Equipment / Anschlüsse zum Hinzufügen von anderer Ausrüstung / Raccordement pour ajouter d'autres appareils / Aansluitingen voor het toevoegen van andere apparatuur

Amplifier / Verstärker / Amplificateur / Versterker

You can connect an amplifier and other equipment to upgrade your car stereo system.

- Connect the remote lead (blue with white stripe) to the remote lead of the other equipment so that it can be controlled through this unit.
- For amplifier only:
 - Connect this unit's line-out terminals to the amplifier's line-in terminals.
 - Disconnect the speakers from this unit, connect them to the amplifier. Leave the speaker leads of this unit unused.
 - For KD-LX330R only: The line output level of this unit is kept high to maintain the hi-fi sounds reproduced from this unit.

When connecting an external amplifier to this unit, turn down the gain control on the external amplifier to obtain the best performance from this unit.

Sie können einen Verstärker oder ein anderes Gerät anschließen, um Ihre Autostereoanlage zu erweitern.

- Schließen Sie das Fernbedienungskabel (blau mit weißem Streifen) an das Fernbedienungskabel des anderen Geräts an, so daß es über dieses Gerät gesteuert werden kann.
- Nur für den Verstärker:
 - Die Anschlußklemmen am Ausgang dieses Gerät an den Anschlußklemmen des Eingangs des Verstärkers anschließen.
 - Die Lautsprecher von diesem Gerät abtrennen und am Verstärker anschließen. Die Lautsprecherleitungen dieses Geräts unbenutzt lassen.
 - Nur für den KD-LX330R: Der Ausgangspegel dieses Geräts wird auf einem hohen Wert gehalten, um den Hi-Fi-Klang zu unterstützen, den dieses Gerät reproduziert.

Wenn Sie einen externen Verstärker an dieses Gerät anschließen, stellen Sie den Verstärkungsregler des externen Verstärkers herunter, um die bestmögliche Leistung dieses Geräts zu erzielen.

Vous pouvez connecter un amplificateur ou autre appareil pour améliorer votre système autoradio.

- Connectez le fil de commande à distance (bleu avec bande blanche) au fil de commande à distance de l'autre appareil de façon qu'il puisse être commandé via cet appareil.
- Pour l'amplificateur seulement:
 - Raccorder les bornes de sortie ligne de cet appareil aux bornes d'entrée ligne de l'amplificateur.
 - Déconnectez les enceintes de cet appareil et connectez-les à l'amplificateur. Laissez les fils d'enceintes de cet appareil inutilisés.
 - Pour le KD-LX330R seulement: Le niveau de sortie de ligne de cet appareil est maintenu à un niveau élevé pour maintenir une qualité Hi-Fi pour les sons reproduits par cet appareil.

Lors de la connexion d'un amplificateur extérieur à cet appareil, diminuez le réglage du gain sur l'amplificateur extérieur pour obtenir les meilleures performances de cet appareil.

Het is mogelijk om uw autostereosysteem uit te breiden met een versterker of andere apparatuur.

- Verbind de externe kabel (blauw met witte streep) met de externe kabel van het andere apparaat zodat deze op afstand vanaf deze apparaat kan worden bediend.
- Alleen voor een versterker:
 - Verbind de uitgang van het apparaat met de ingang van de versterker.
 - Koppel de speakers van dit apparaat los en verbind ze aan de versterker.
 - Alleen voor KD-LX330R: Het uitgangsniveau van het geluid is hoog om het hi-fi-geluid van deze eenheid te behouden.

Wanneer u een extern apparaat op deze eenheid aansluit, moet u erop letten dat u de versterkingsfactor van de externe versterker laag houdt, zodat deze eenheid de beste prestaties levert.

Signal cord (not supplied with this unit)
Einzelleitung (nicht mit diesem Gerät mitgeliefert)
Cordon de signal (non fourni avec cet appareil)
Signaalkabel (wordt niet bij dit apparaat geleverd)

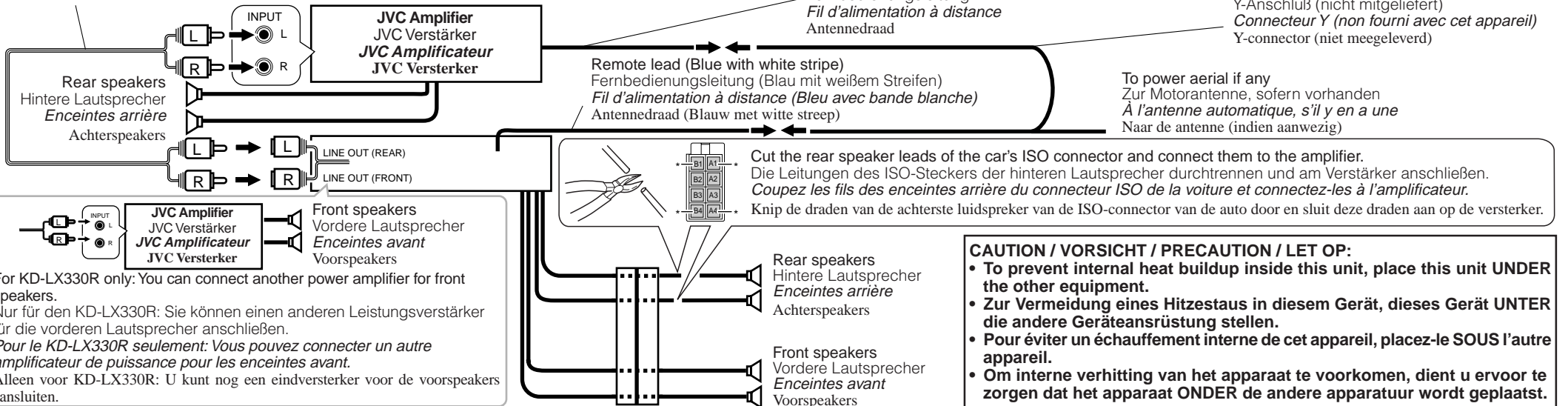

CD changer and DAB tuner / CD-Wechsler und DAB-Tuner / Changeur CD et tuner DAB / CD-wisselaar en DAB-tuner

You can connect a JVC CD changer and/or a JVC DAB (Digital Audio Broadcasting) tuner.

- For their connections, refer to the instructions supplied with them.

Sie können einen CD-Wechsler und/oder einen DAB-Tuner (Tuner für digitalen Rundfunk) von JVC anschließen.

- Weitere Informationen über den Anschluß können Sie der Bedienungsanleitung entnehmen, die dem jeweiligen Gerät beiliegt.

Vous pouvez connecter un changeur CD JVC et/ou un tuner DAB (Digital Audio Broadcast) JVC.

- Pour leurs connexions, référez-vous aux modes d'emploi qui les accompagnent.

Het is mogelijk een JVC CD-wisselaar en/of JVC DAB-tuner (Digital Audio Broadcasting) aan te sluiten.

- Zie de instructies van deze apparaten voor meer informatie over het tot stand brengen van deze aansluiting.

Connecting cord supplied with your DAB tuner
Verbindingskabel, dat zum Lieferumfang des DAB-Tuners gehört
Cordon de connexion fourni avec votre tuner DAB
Verbindingskabel die met de DAB-tuner wordt meegeleverd

Connecting cord supplied with your CD changer
Verbindingskabel, dat zum Lieferumfang des CD-Wechsler gehört
Cordon de connexion fourni avec votre changeur CD
Verbindingskabel die met de CD-wisselaar wordt meegeleverd

Connecting cord supplied with your DAB tuner or CD changer
Verbindingskabel, dat zum Lieferumfang des DAB-Tuners oder CD-Wechslers gehört
Cordon de connexion fourni avec votre tuner DAB ou changeur CD
Verbindingskabel die met de DAB-tuner of CD-wisselaar wordt meegeleverd



External component / Externe Komponente / Appareil extérieur / Extern apparaat

FOR KD-LX330R / FÜR DEN KD-LX330R / POUR LE KD-LX330R / VOOR KD-LX330R

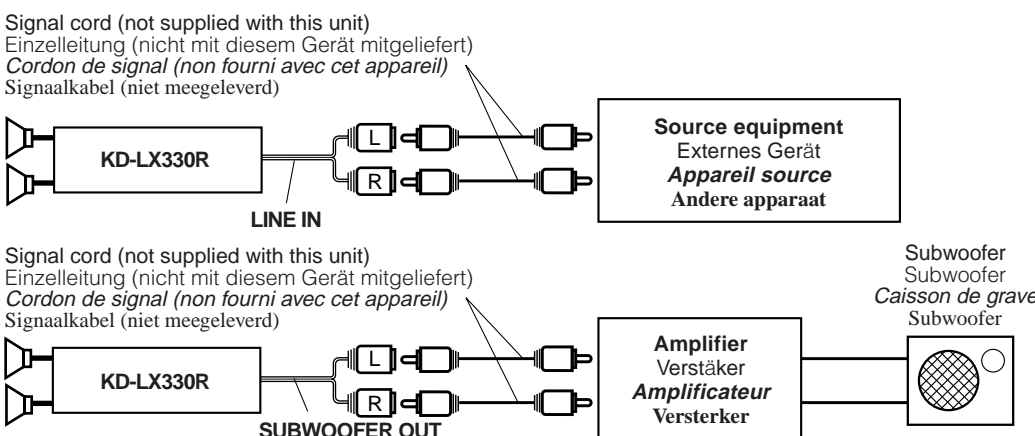

FOR KD-LX110R / FÜR DEN KD-LX110R / POUR LE KD-LX110R / VOOR KD-LX110R

